

Signal Interfaces

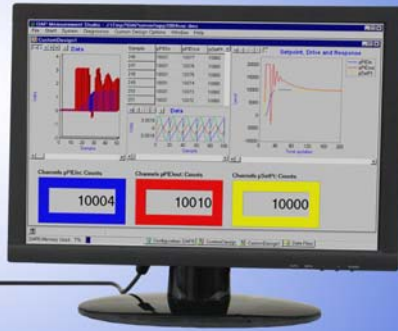

Onboard Intelligence

Signal Interfaces

Anti-Aliasing

System Integration

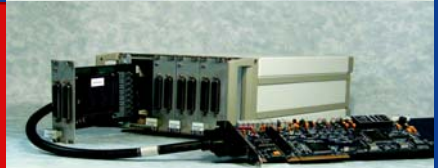

MICROSTAR
LABORATORIES™

Signal Interfaces

connecting the world to a DAP board

Data Acquisition Processor (DAP) boards controlled from PCs form the foundation of any new system from Microstar Laboratories. A channel architecture based on Eurocards – plug-in hardware that mounts in industry-standard 19” racks – provides expansion, termination, and other functions that greatly increase the range of even a single DAP.

Introducing This Catalog

This catalog guides you through the channel architecture that Microstar Laboratories uses. It does so in enough detail to allow you to select all the components required to configure your DAP system and then to calculate its cost from our price list.* It includes photographs of most Eurocards and of the more popular cables, and it gives enough information on part numbers to act as a useful index to the complete set of all user manuals on every hardware product the company ships to customers. If you do not yet have all our user manuals, please ask us for them. You can do this right now by phone or on the Web. If you do not have our current price list please ask us for that as well.



During your visit to our Web site, you can download the DAPtools Basic CD. This contains all our user manuals for all our software and hardware products in Windows Help format as well as in PDF format. When you want more detail on a product than you can find in this catalog, please refer to the relevant user manual on this CD.

Microstar Laboratories claims the following as trademarks: Microstar Laboratories, Data Acquisition Processor, DAP, DAPL, DAP 820, DAP 840, DAP 4000a, DAP 4400a, DAP 5000a, DAP 5016a, DAP 5200a, DAP 5216a, DAP 5380a, DAP 5400a, iDSC, iDSC 1816, DAPcell, DSCview, DAPstudio, and DAPtools.

Microsoft Corporation has registered Microsoft and Windows as trademarks. Opto 22 has registered Opto and Opto 22 as trademarks.

These and other companies may claim – or may have registered – trademarks, trade names, logos, and service marks that appear in this document but not in the list above.

Microstar Laboratories makes it a practice to use an appropriate symbol at the first occurrence of a trademark or registered trademark name in a document, or to include trademark statements like this with the document.

Microstar Laboratories, Inc.
2265 116th Ave. NE
Bellevue, WA 98004
U.S.A.

Telephone: 425 453-2345
Fax: 425 453-3199

E-mail:
info@mstarlabs.com
sales@mstarlabs.com
appeng@mstarlabs.com

www.mstarlabs.com

Microstar Laboratories warrants all hardware products for one year. After that, the company will repair products at minimal cost if vendors still supply any parts needed. In practice, Microstar Laboratories buys discontinued parts for inventory to prolong the useful life of older products. Please ask for a copy of the Microstar Laboratories Limited Warranty for details of the one-year warranty.

* You can ask us to do this for you, of course. Just call

888 MSTARLABS (888 678-2752)

A Message to New Customers and Old Friends

Your success matters to us. We make it our business to help you succeed in what you do; we listen carefully to what you want to achieve, show you, if we can, how to use our products to do that, and support you while you work toward your goals.

You teach us; we respect you and thank you for that. We learn from you what to build into our business processes and products so that you find us even more helpful the next time you call on us.

Meanwhile, and before you turn the page, please also read the introduction on the left.

Best wishes,

Neil Fenichel
President
Microstar Laboratories, Inc.

Neil Fenichel founded Microstar Laboratories in 1982. As often as he can, he works directly with customers alongside company application engineers.

Customers

Our customers cover almost all fields of industry and science, and range in size from one-person operations to Fortune 500 companies. They include a growing number of VARs and OEMs (Value Added Resellers and Original Equipment Manufacturers).

For customers large or small, reseller or end user, we offer a unique approach to PC-based data acquisition. You can see for yourself on our Web site how some of our customers make use of this approach in their applications.

Products

Microstar Laboratories produces a line of Data Acquisition Processor (DAP) boards, each with an onboard processor, memory, and a dedicated, multitasking, real-time operating system: DAPL. With this onboard intelligence, a DAP board can handle time-critical aspects of an application without any delays or resource demands imposed by Windows or by other software running on the PC.

Applications require onboard intelligence to run in real time under Windows. However, onboard intelligence also makes it much easier to implement applications requiring a high channel count, anti-aliasing, or synchronized integration over a network.

As well as providing DAPL software to run on DAP boards, we develop and ship PC software to support DAP boards in many user environments. All our design follows a channel architecture that makes it easy to connect our hardware to a large array of sensors and actuators.

Support

Microstar Laboratories provides complete technical support to each customer. When you first call us, an application engineer examines how well our products fit your proposed application. If our products do not fit, we say so. If our products fit, we work with you until your application runs as planned.

Hardware and software engineers work with application engineers to provide the technical support you need to reach your goals.

To talk about your application, call us toll free in the United States, at 888 MSTARLABS (678-2752). Outside the United States, email us or contact one of our international distributors.

For more information, please visit our Web site. From there you can download – or ask us to send you – a CD that contains every user manual we publish.

Note: Pages in this catalog are numbered to match PDF numbering.

Systems – Desktop and Lab Bench

The channel architecture used by Microstar Laboratories lets you easily configure a system that neither receives nor radiates electromagnetic interference. To configure such a system, select only enclosure versions of the Eurocards you need from the table on page 28.



Single-Board Enclosure: Input Side



Single-Board Enclosure: DAP-Connection Side

- ◆ in electrically quiet, protected environments
- ◆ access is important, reconfiguration frequent
- ◆ shielding and protection secondary



For systems with these requirements, use component-level equipment and bench-top enclosures.

If you plan to use industrial enclosures that mount in standard 19-inch racks, choose Eurocards with part-number suffixes E2x or E3x – for analog and digital backplanes respectively. See **Instrumentation Rack** below for more on selecting these rack-mount enclosures and on specifying shielded connections from them to a DAP.

If your application requires only a small number of channels, you may prefer to use a free-standing enclosure for each Eurocard. So choose Eurocards with the other part-number suffixes shown on page 28. Microstar Laboratories ships each of these pre-installed in its own single-board enclosure.

From the table on page 29, choose the appropriate cable or connection to a DAP, and decide on the type of connector for sensors or actuators. If you decide on a blank panel, make sure that you shield your custom connector to meet EMC Directive 89/336/EEC.

By following these steps and – as required – those under **Instrumentation Rack** below, you will have configured a system that neither receives nor radiates electromagnetic interference and that meets or exceeds every requirement of EMC Directive 89/336/EEC issued by the EU.

Systems – Instrumentation Rack

Several Eurocards can fit into each factory-installed backplane in every industry-standard, full-size, 19-inch rack-mountable enclosure. Eurocard part number suffixes E2x or E3x denote the required backplane type: analog or digital. (See pages 28-29 for more suffix information.)

The installed backplanes come in three variations: full-size analog, full-size digital, or half-size analog and half-size digital. A full-size enclosure can accept two half-size backplanes. Microstar Laboratories also offers half-size enclosures with single half-size backplanes installed.

Each backplane has a factory-installed DAP interface board, analog or digital as appropriate. With interface boards installed, full-size backplanes have 20 available slots; half-size backplanes have nine. The table on page 29 lets you see how many slots your chosen Eurocards occupy, and from that you can decide what industrial enclosures you need.

If you want to package Eurocards in third-party enclosures, you can buy backplanes and analog or digital interface boards as separate items. This catalog provides related details on pages 26 and 27. We do not include the items in published price lists. The Eurocard part number suffixes for these interface boards do not follow the usual convention.

The 3-D line drawings on page 8 show shielded cable connections between enclosures and DAPs. Choose these MSCBL part numbers to prevent electromagnetic interference. More details follow on page 30.

Systems – Instrumentation Rack (Continued)

- ◆ reliable packaging for production applications
- ◆ support large-scale systems
- ◆ environmental protection and shielding
- ◆ integration with other instrumentation and controls



For systems with these requirements, use industrial rack-mounted enclosures.

The available Industrial Enclosure options include

- MSIE 001-01** Half-size industrial enclosure with an analog backplane and interface
- MSIE 002-06** Full-size industrial enclosure with a full-size analog backplane and interface
- MSIE 010-06** Full-size industrial enclosure with two half-size analog backplanes and interface
- MSIE 003-01** Half-size industrial enclosure with a digital backplane and interface
- MSIE 004-06** Full-size industrial enclosure with a full-size digital backplane and interface
- MSIE 011-06** Full-size industrial enclosure with two half-size digital backplanes and interface
- MSIE 005-06** Full-size industrial enclosure with one half-size analog backplane (on the left side) and one half-size digital backplane (on the right side), both with interfaces
- MSIE 012-06** Full-size industrial enclosure with one half-size analog backplane (on the right side) and one half-size digital backplane (on the left side), both with interfaces
- MSIE 009-06** Full-size industrial enclosure with no backplane or interface

Interface boards come pre-installed in the above products (except for MSIE 009); order all other Eurocards separately.

If you have custom requirements, please contact us for more information.

Of course, if your system does not require packaging, or if you have no concerns about EMI, you always can buy stand-alone Eurocards.



Half-Size Industrial Enclosure



Full-Size Industrial Enclosure, Interface Cards at Left and Right



MSIE 010 – Full-Size Industrial Enclosure, MSXB 027



Two Full-Size Industrial Enclosures, Daisy-Chain



- ◆ OEM pre-integration of components
- ◆ networked operation, or stand-alone workstation
- ◆ terminations, acquisition, and host combined
- ◆ built for harsh operating conditions



For systems with these requirements, use a DAPserver system, with integrated acquisition and networking ready to go.

DAPserver packages for heavy industry

- built-in signal-interface rack
- connector panels
- data acquisition processor boards
- signal backplane
- local data storage
- ventilation
- electrical shielding
- PC-based local host
- Windows or Linux pre-installed

Add an Ethernet cable and you have a remote data acquisition system. Add a keyboard, pointing device, and monitor and you have a complete on-site workstation, as well as a full-service data acquisition system.

The DAPserver Product Line

The DAPserver 500 and DAPserver 502 – and the DAPserver 500R and 502R, the latter "R" models for rugged environments – serve as fully integrated test, measurement, and control products. Built with experience gained over many years of integrating third-party hardware, these high-performance combined systems are now available as standard products, with the built-in value and quality engineering that go with all Microstar Laboratories systems.

Each DAPserver comes preloaded with Linux or Windows, ready for installation of application software. A DAPserver mounts in an industry-standard 19-inch rack, and includes a SATA hard drive. DAPcell client software on any PC can request data acquisition or control services from DAP boards on any DAPserver on the same network. DAPserver input and output design conforms to Microstar Laboratories Channel Architecture.



Host Processor Bus

Each DAPserver contains a five-slot, PCI-format card cage, with pre-installed host-bus backplane. A single-board computer (SBC) with a Pentium M 1.8GHz processor occupies one slot, leaving four available slots for mounting Data Acquisition Processor boards of any type – including the iDSC 1816: a specialized DAP with onboard analog filters.

The Hardware Side of Channel Architecture

A multiple-DAP measurement system could have several thousand analog and digital signals, both inputs and outputs. Hardware devices used for Channel Architecture bring signals into connectors on 3U (100mm high) Eurocard B (220mm deep) boards – Eurocards. Some boards apply hardware-supported signal pre-processing in addition to simple signal termination.

All Microstar Laboratories Eurocards – other than DAP-to-backplane interfaces – offer one or more types of termination. They provide multiplexing, isolation, filtering, simultaneous sampling, signal conditioning, and other functions. The DAPserver 500/502 models each contain a 10-slot card cage with Eurocard B-format dimensions and a pre-installed backplane. The card cage for the DAPserver 500 is compatible with Microstar Laboratories analog expansion boards; the one for the DAPserver 502 is compatible with Microstar Laboratories digital expansion boards. If you need more than ten Eurocards, you can connect to additional industrial enclosures.

Networking with DAPservers

Channel Architecture does not stop at the signal connectors. It is a service architecture, that lets "server" nodes take care of the details of signal conditioning, collection and pre-processing, while leaving "client" nodes to manage data, coordinate processes, and update graphical data presentation displays for users.

The single board computer includes networking support, so you do not need a separate network card. Networking the DAPserver is no different and no harder than configuring PC workstations on any other local area network. The computer board also provides connectors for keyboard, mouse, and monitor, and you can use these to operate the DAPserver as a stand-alone system.

DAPcell Server Software

DAPcell server networking software makes the resources of all the data acquisition boards at its station available to any station running DAPcell client software on the same network connection.

DAPcell Client Software

Any station on the network can use DAPcell client networking software to start and stop processing, monitor progress, and receive resulting data sets from a Data Acquisition Processor installed in any server station on the network. The network is transparent to your data acquisition and control application. You can access a networked Data Acquisition Processor as easily as you would select a printer.

User Interfaces

Client systems are free to run any kind of software system, including major data presentation packages such as *DASYLab*, *LabVIEW*, or *VEE*. Such systems are not required, however. You can integrate data acquisition functions into your own custom software. Or you can use DAP Measurement Studio (DAPstudio) to quickly configure applications that have straightforward data logging and display requirements.

Each DAPserver comes with DAPtools Professional – a software package that includes DAPcell, the Developer's Toolkit for DAPL, and a full version of DAPstudio – preloaded.



Stand-Alone Board

Application does not require enclosed hardware.

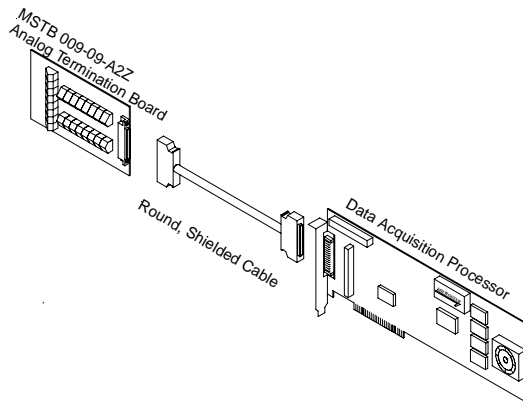

Signal Interfaces

Single-Board Enclosures

Application has only a few inputs and outputs.

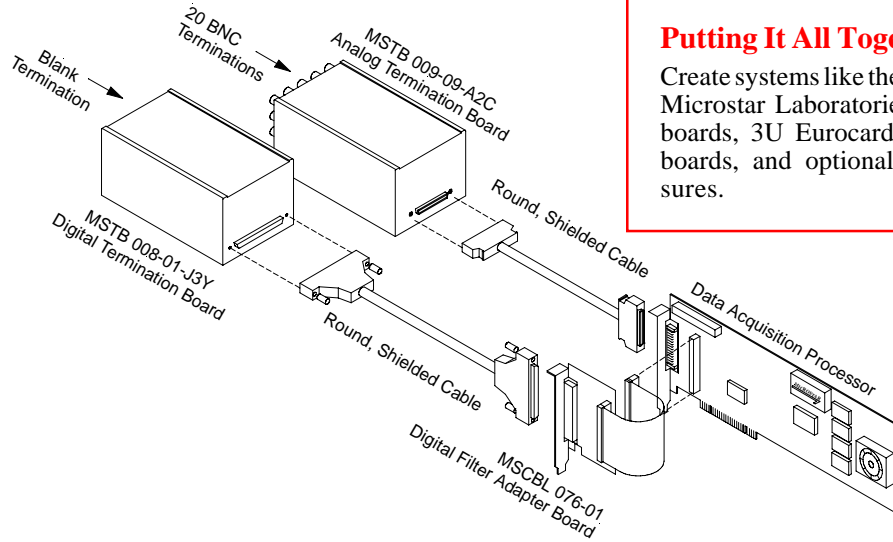

Putting It All Together

Create systems like these with Microstar Laboratories DAP boards, 3U Eurocard-format boards, and optional enclosures.

Industrial Enclosures

Application may have many inputs and outputs.

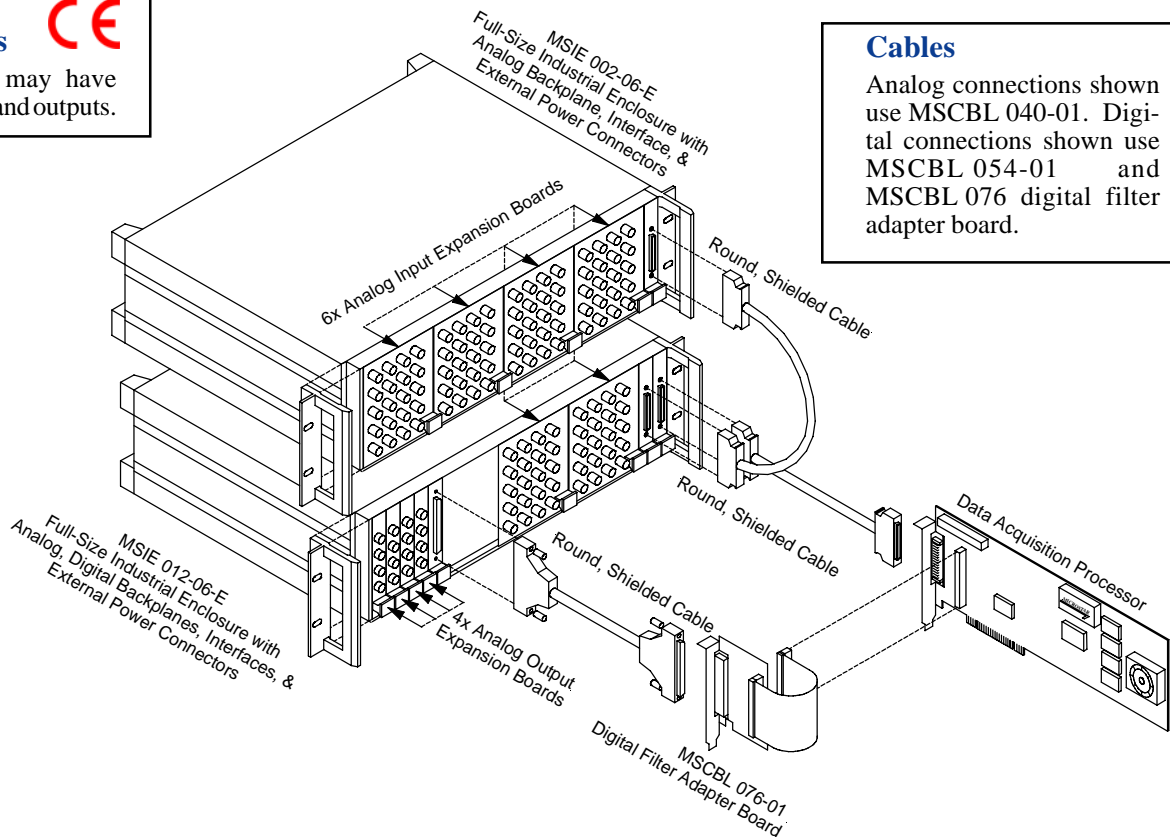

Cables

Analog connections shown use MSCBL 040-01. Digital connections shown use MSCBL 054-01 and MSCBL 076 digital filter adapter board.

Several DAP boards – in any combination of model numbers – can work together as a single, synchronized, PC-based system¹. Some simple DAP systems will have only a handful of inputs and outputs; others may have maybe a hundred or so. A multi-DAP system could have several thousand analog and digital inputs and outputs. Whatever the case, the signals have to connect somewhere. The examples here illustrate the channel architecture used by Microstar Laboratories: signal connectors on 3U (100mm high) Eurocard B² (220mm deep) boards – Eurocards – that often pre-process a signal.

All Microstar Laboratories Eurocards – other than DAP-to-backplane interfaces – offer one or more types of termination. Most also multiplex inputs or outputs. Many perform additional functions. On the right you can review the full range, arranged in the eight main function groups:

- simple termination
- simple multiplexing
- anti-alias filtering
- simultaneous sampling
- isolation
- counter/timer
- quadrature-decoder
- signal conditioning

The need for one or more of the listed functions, the number and speed of inputs and outputs, the mix of analog and digital signals, and termination choices – as well as the extent that your application can benefit from onboard processing – determines the DAP board, Microstar Laboratories Eurocards, and enclosure models required.

Account Representatives and Application Engineers at Microstar Laboratories know the product range, they know how it works in a number of applications, and they welcome the opportunity to talk with you about how it can work in yours.

So call us. 888 678-2752

We can confirm a suitable channel architecture and an overall signal configuration, illustrated by a 3-D line drawing, like the samples you see here. You will clearly see the products you need and the ways they connect. We do not charge for this service, so go ahead and contact us today.

Eurocards by Function

Simple Termination (See related products below)

- MSTB 008: Digital Termination Boards
- MSTB 009: Analog Termination Boards
- MSTB 010: Termination Boards for the DAP 840
- MSTB 011: Analog Termination Boards with DB37 Connectors

Simple Multiplexing

- MSXB 084: Isolated Analog Input Expansion Boards
- MSXB 078: Isolated Digital Expansion Boards
- MSXB 075 & MSXB 076: Isolated 16-Bit Analog Output Expansion Boards
- MSXB 060 & MSXB 061: Differential Analog Input Expansion Boards
- MSXB 038: Digital Expansion Boards
- MSXB 037: Analog Input Expansion Boards

Anti-Alias Filtering

- MSXB 067: Signal Conditioning & Filtering Expansion for Resistive Sensors
- MSXB 065: Signal Conditioning and Filtering Expansion for Voltage Inputs
- MSXB 048: Filtered Analog Input Expansion Boards

Simultaneous Sampling

- MSXB 067: Signal Conditioning & Filtering Expansion for Resistive Sensors
- MSXB 066: Signal Conditioning Expansion Boards for Resistive Sensors
- MSXB 065: Signal Conditioning and Filtering Expansion for Voltage Inputs
- MSXB 064: Signal Conditioning Expansion Boards for Voltage Inputs
- MSXB 028: Simultaneous Sampling Boards

Isolation

- MSXB 084: Isolated Analog Input Expansion Boards
- MSXB 078: Isolated Digital Expansion Boards
- MSXB 075 & MSXB 076: Isolated 16-Bit Analog Output Expansion Boards
- MSXB 039: Digital Opto-Isolator Boards
- MSXB 027: Analog Isolation Boards

Counter/Timer

- MSXB 036: Counter/Timer Boards

Quadrature-Decoder

- MSXB 050: Quadrature Decoder Boards

Signal Conditioning (See related products below)

- MSXB 067: Signal Conditioning & Filtering Expansion for Resistive Sensors
- MSXB 066: Signal Conditioning Expansion Boards for Resistive Sensors
- MSXB 065: Signal Conditioning and Filtering Expansion for Voltage Inputs
- MSXB 064: Signal Conditioning Expansion Boards for Voltage Inputs

Related products for the iDSC 1816, a specialized DAP board that filters out all aliases and samples all channels simultaneously:

Eurocards

- MSXB 042: Analog Termination Boards
- MSXB 044: Signal Conditioning Boards included in MSSC-8 module – itself included in the SCS-xx Signal Conditioning Systems packages

Other Boards

- MSXB 043: BNC Termination Boards
- MSXB 045: LVDS Boards for iDSC synchronization with multiple iDSC 1816 boards

¹ On one PC or several networked PCs. DAPcell software allows a number of DAP boards to act as a single synchronized system even though spread across networked PCs.

² The Eurocard A format, used in CompactPCI systems, has the same 3U height (100mm) but not the depth: 160mm against 220mm for the Eurocard B format.

Analog	Simple Termination	Simple Multiplexing	Anti-Alias Filtering	Simultaneous Sampling	Isolation	Signal Conditioning	DAP Compatibility	More information
MSTB 009	16 analog in, 2 analog out						a b	p. 12
MSTB 010	8 analog in, 2 analog out, 8 digital in, 8 digital out						c	p. 12
MSTB 011	16 analog in, 2 analog out						a b	p. 13
MSXB 027					8 5B	Y	a b	p. 18
MSXB 028				16 single-ended analog in			a b	p. 24
MSXB 037		16 single-ended analog in OR 8 differential analog in					a b	p. 14
MSXB 048			16 single-ended analog in			Y	a b	p. 17
MSXB 060		32 differential analog in					a	p. 14
MSXB 061		64 differential analog in					a	p. 14
MSXB 064				Y		8 differential analog in	a	p. 21
MSXB 065			Y	Y		8 differential analog in	a	p. 21
MSXB 066				Y		8 differential analog in	a	p. 22
MSXB 067			Y	Y		8 differential analog in	a	p. 23
MSXB 075		4 single-ended analog out, 16-bit			Y		a	p. 15
MSXB 076		8 single-ended analog out, 16-bit			Y		a	p. 15
MSXB 084		16 differential analog in, 16-bit			Y		a	p. 18
MSXB 085	16 differential analog in, 2 analog out, 16-bit				Y		a	p. 18

Digital	Simple Termination	Simple Multiplexing	Isolation	Counter/Timer	Quadrature Decoder	DAP Compatibility	More information
MSTB 008	16 digital in/ out					a	p. 12
MSTB 010	8 analog in, 2 analog out, 8 digital in, 8 digital out					c	p. 12
MSXB 036		16 digital in, 16 digital out		10 counter/ timer channels		a	p. 16
MSXB 038		16 digital in, 16 digital out				a	p. 16
MSXB 039			8 Opto			a	p. 19
MSXB 050					4 quadrature pairs	a	p. 24
MSXB 078		16 digital in, 16 digital out	Y			a	p. 19

Digital	Simple Termination	Simple Multiplexing	Isolation	Counter/Timer	Quadrature Decoder	DAP Compatibility	More information
---------	--------------------	---------------------	-----------	---------------	--------------------	-------------------	------------------

Analog for iDSC 1816	Simple Termination	Anti-Alias Filtering	Signal Conditioning	DAP Compatibility	More information
MSXB 042	8 analog in	through the iDSC 1816		d	p. 25
MSXB 043	8 analog in	through the iDSC 1816		d	p. 25
MSXB 044		through the iDSC 1816	2 differential analog in	d	p. 25
MSXB 045				d	p. 25

Analog for iDSC 1816	Simple Termination	Anti-Alias Filtering	Signal Conditioning	DAP Compatibility	More information
----------------------	--------------------	----------------------	---------------------	-------------------	------------------

DAP Compatibility: Shows compatibility with different groups of DAP boards

- a: Compatible with DAP 5216a, DAP 5200a, DAP 5016a, DAP 5000a, and DAP 4000a/212 boards
On the following pages, look for boards in **Green** or **Blue** blocks.
(for information on compatibility with the DAP 4000a/112 model, see p. 25)
- b: Compatible with analog-only DAP 5400a and DAP 5380a boards
On the following pages, look for boards in **Blue** blocks.
- c: Compatible with DAP 840 boards
On the following pages, look for boards in **Orange** blocks.
- d: Compatible with iDSC 1816 boards
On the following pages, look for boards in **Cyan** blocks.

Key for All Items

Compatible with DAP 840

Compatible with iDSC 1816

See page 25 for products compatible with DAP 4000a/112.

Compatible with DAP 5216a, DAP 5200a, DAP 5016a, DAP 5000a, and DAP 4000a/212

Compatible with DAP 5216a, DAP 5200a, DAP 5016a, DAP 5000a, and DAP 4000a/212 PLUS DAP 5400a and DAP 5380a

Eurocards for Simple Termination

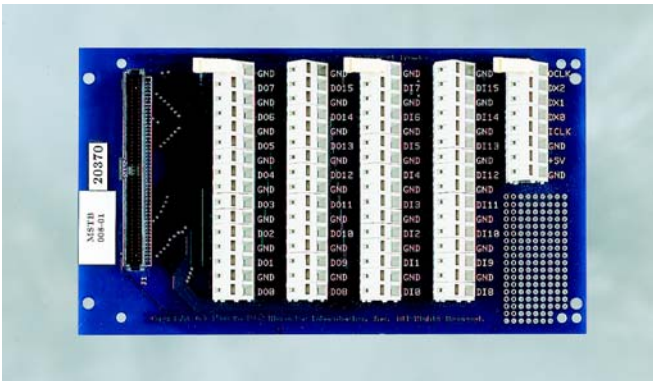

MSTB 008 Digital Termination

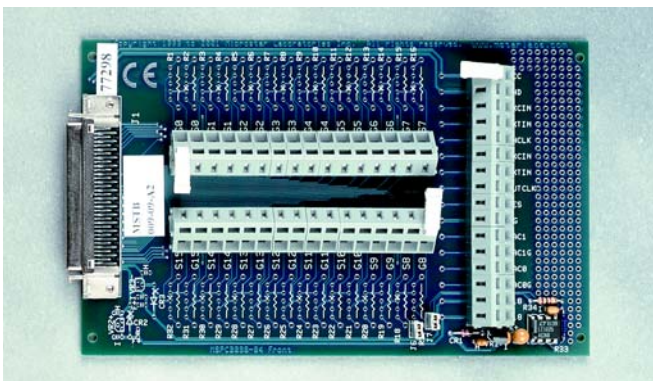

MSTB 009 Analog Termination

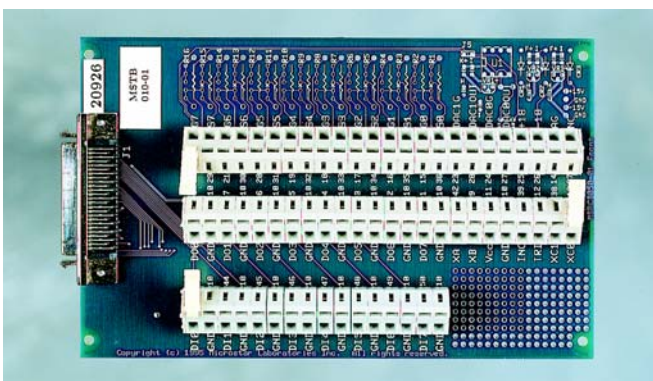

MSTB 010 Termination

MSTB 008 Digital Termination

The MSTB 008 Digital Termination Board allows quick and secure connection of discrete wires to a DAP.

MSTB 008 requires cable MSCBL 036-01.

- **Model MSTB 008-03** **Wago terminals**
- **Model MSTB 008-02** **screw terminals**

MSTB 009 Analog Termination

The MSTB 009 Analog Termination Board allows quick and secure connection of discrete wires to Data Acquisition Processors.

MSTB 009 includes locations to install voltage divider resistors and 0-20mA termination resistors, as well as a Cold Junction Compensation (CJC) circuit for thermocouple applications.

- **Model MSTB 009-09** **Wago terminals**
- **Model MSTB 009-10** **screw terminals**

MSTB 010 Termination

The MSTB 010 Termination Board allows quick and secure connection of discrete wires to a DAP 840. MSTB 010 combines analog and digital termination on the same board.

MSTB 010 boards includes locations for voltage divider resistors and 0-20mA termination resistors. Models include onboard cold junction compensation circuitry for thermocouple applications.

Cable MSCBL 048-01 or MSCBL 050-01 is required.

- **Model MSTB 010-06** **Wago terminals**
- **Model MSTB 010-08** **screw terminals**

Eurocards for Simple Termination (Continued)

MSTB 011 (no photo shown) Analog Termination, DB37 Connector

The MSTB 011 a-Series Analog Termination Board allows quick and secure connection of discrete wires to a Data Acquisition Processor system through a DB-37 connector and an MSXB 048 or other expansion board with DB-37 I/O.

MSTB 011 includes locations to install voltage divider resistors and 0-20mA termination resistors.

Cable MSCBL 040-01 or MSCBL 041-01 is required..

- **Model MSTB 011-01** **Wago connection points, DB-37 connector**
- **Model MSTB 011-02** **screw terminal connection points, DB-37 connector**

Eurocards for Simple Multiplexing – Analog Inputs (for existing systems only)

MSXB 018 Analog Input Expansion

The MSXB 018 Analog Input Expansion Board expands 16 analog input lines to 64 analog input lines. The MSXB 018 provides four expansion ports compatible with MSTB 009 Analog Termination Boards.

MSXB 018 requires cable MSCBL 040-01 or MSCBL 041-xx. Two or more units may be daisy-chained on cable MSCBL 041-xx.

- **Model MSXB 018-04** **with sockets and fault-protected multiplexers**

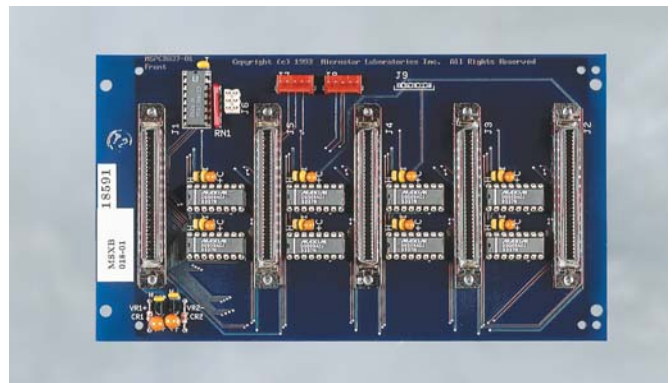

MSXB 018 Analog Input

Note: Eurocards for *most* functions are available in unenclosed versions. Eurocard MSXB 018 is available *only* in unenclosed versions. Eurocards MSTB 008, MSTB 009, and MSTB 010 are available also in single-board enclosures.

Eurocards for Simple Multiplexing – Analog Inputs

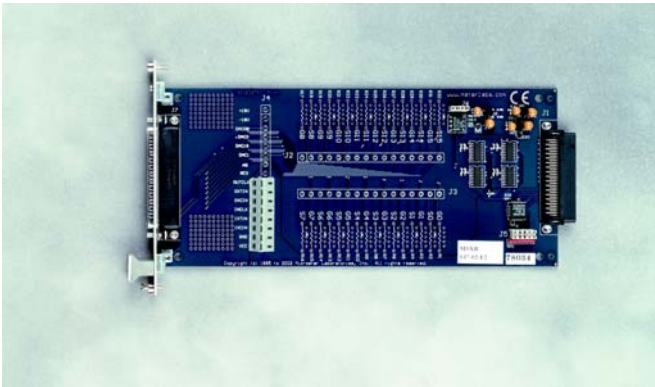

MSXB 037 Analog Input Expansion

MSXB 037 Analog Input Expansion

The Microstar Laboratories Analog Input Expansion Board, part number MSXB 037, provides analog input expansion for Analog Backplane systems. The Analog Input Expansion Board is compatible with the MSXB 030-01 and MSXB 031-01 Analog Backplanes.

The Analog Input Expansion Board provides 16 single-ended or eight differential analog inputs with onboard termination points. Up to 32 Analog Input Expansion Boards can be connected to a DAP for 512 inputs.

- **Model MSXB 037-02** **DB37 connector**
- **Model MSXB 037-03** **Wago terminals**

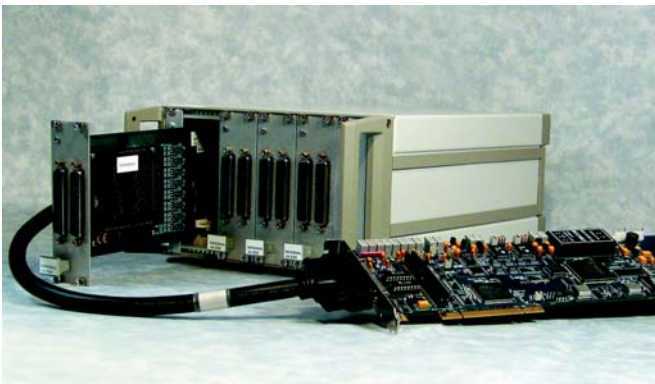

MSXB 061: 4 MSXB 061 boards in a half-size enclosure connected to a DAP board: 256 channels of differential input, in a single package.

MSXB 060 and MSXB 061 Differential Analog Inputs

These Analog Input Expansion Boards provide differential analog inputs. MSXB 060 offers 32 differential inputs per board. MSXB 061 offers 64 differential inputs per board. Up to four MSXB 061 Analog Input Expansion Boards can be connected to a single DAP board for 256 differential analog inputs. Multiple DAP boards can be used for higher channel count systems.

The system shown in the photo includes four MSXB 061 boards in a half-size enclosure connected to a DAP board: 256 channels of differential input in a single package.

The MSXB 060 and MSXB 061 provide analog input expansion for Analog Backplane systems. The Analog Input Expansion Board is compatible with the MSXB 030-01 and MSXB 031-01 Analog Backplanes.

- **Model MSXB 060-01** **right-angle HD78 connector**
- **Model MSXB 061-01** **two right-angle HD78 connectors**

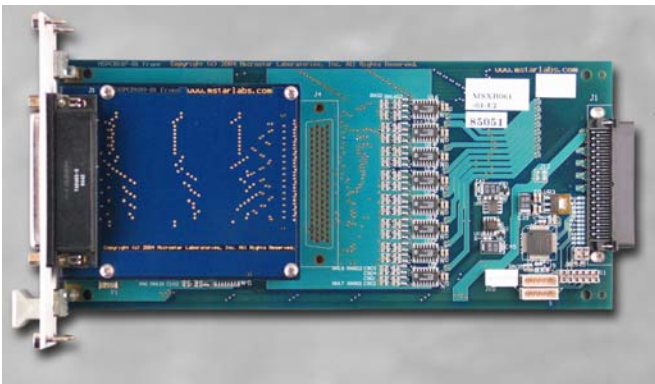

MSXB 061 Differential Analog Inputs

MSXB 084 Isolated Analog Input Expansion

See **Isolation – Analog (p. 18)** for more information.

MSXB 085 Isolated Analog Input and Output

See **Isolation – Analog (p. 18)** for more information.

Eurocards for Analog Outputs (Connects to the Digital Port)

MSXB 075 and MSXB 076 Isolated 16-Bit Analog Output Expansion

The MSXB 075 and MSXB 076 Isolated 16-Bit Analog Output Boards provide isolated analog outputs for DAP systems. Use these boards to eliminate ground currents – a potential source of noise in your measurement and control signals – as well as to eliminate phase errors from analog outputs in your application.

MSXB 075 includes four single-ended analog outputs, with an isolated ground for each output, and features simultaneous updating for multiple boards, across all channels. Each board provides cost-effective isolation for those systems with only a few analog outputs.

MSXB 076 includes eight single-ended analog outputs, with an isolated ground for each output, and features simultaneous updating for multiple boards, across all channels. Each board offers high signal density and enables high channel counts.

Up to eight MSXB 076 boards can connect to a single DAP board to provide isolated analog output at a low cost per channel. Contact applications engineering at Microstar Laboratories for higher channel count systems.

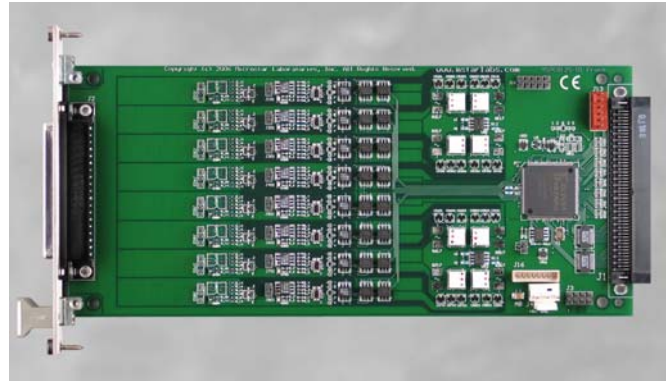

MSXB 076 Isolated 16-Bit Analog Output Expansion

The Isolated Analog Output Expansion Boards connect to the Data Acquisition Processor's digital connector. If digital input/output is needed in addition to analog output expansion, a Digital Expansion Board is required.

There are several cabling options for the MSXB 076 Analog Output Expansion Board. The board may be connected to a DAP using various 100-line cabling options, or can be installed into a Digital Backplane.

- Model MSXB075-01 Wago terminals
- Model MSXB076-01 Wago terminals

Eurocards for Analog Outputs (for existing systems only)

MSXB 032 Analog Output Expansion

The MSXB 032 Analog Output Expansion Board converts digital inputs from a Data Acquisition Processor into four separate analog outputs. Up to 16 Analog Output Expansion Boards can be connected to a Data Acquisition Processor for a maximum expansion of 64 analog output channels.

The MSXB 032 is being replaced by the MSXB 075 and MSXB 076 models.

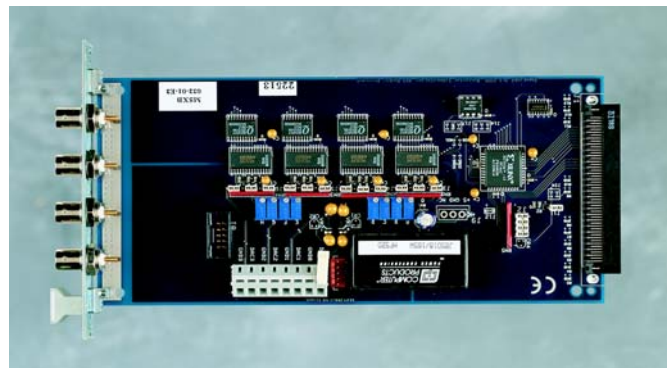

MSXB 032 Analog Output Expansion

MSXB 056 16-Bit Analog Output Expansion

The MSXB 056 16-bit Analog Output Expansion Board provides four additional analog outputs with 16-bit resolution. Up to 16 Analog Output Expansion Boards can be connected to a single DAP for a total of 64 additional output channels.

The MSXB 056 is being replaced by the MSXB 075 and the MSXB 076.



MSXB 056 16-Bit Analog Output Expansion

Eurocards for Simple Multiplexing – Digital

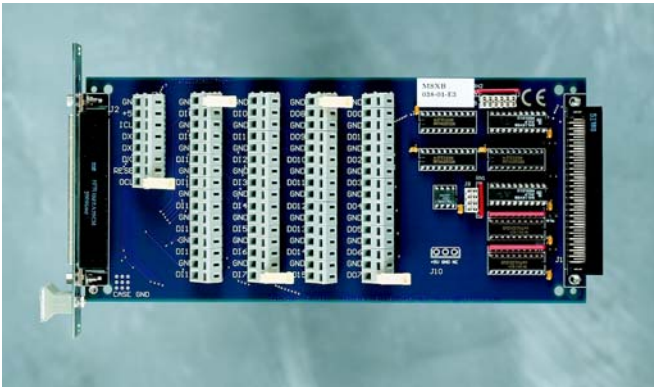

MSXB 038 Digital Expansion

MSXB 038 Digital Expansion

The MSXB 038 Digital Expansion Board provides 16 digital inputs and 16 digital outputs.

Multiple Digital Expansion Boards can be connected to a single DAP for a total of 128 digital input lines and 1024 digital output lines. Input expansion is at a maximum with two MSXB 038 boards (128 points). Output can be expanded to 1024 points by connecting 16 MSXB 038 boards to a single DAP.

There are several cabling options for the MSXB 038 Digital Expansion Boards. MSXB 038 may be connected to a DAP using various 100-line cabling options, or can be installed into a Digital Backplane.

Available models include

- **Model MSXB 038-07** **Wago terminals**
- **Model MSXB 038-08** **screw terminals**
- **Model MSXB 038-09** **Wago terminals,**
 vertical I/O connector
- **Model MSXB 038-11** **Wago terminals,**
 HD-62 connector with
 LED panel

MSXB 036 Counter/Timer

See **Counter/Timer (below)** for more information.

MSXB 078 Isolated Digital Output Expansion

See **Isolation – Digital (p. 19)** for more information.

Eurocards for Counter/Timer – Digital

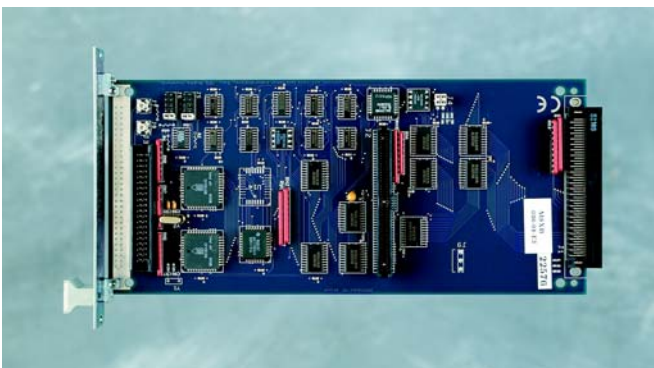

MSXB 036 Counter/Timer

MSXB 036 Counter/Timer

The MSXB 036 Counter/Timer Board is used for frequency counting, rotational speed (tachometer) measurement, and closed-loop process control based on frequency criteria. Engine performance monitoring is a typical application.

The Counter/Timer Board provides 16 digital input lines and 16 digital output lines, counts up to 6 MHz on 10 channels, and has two 100 MHz frequency prescalers.

There are several cabling options for the MSXB 036 Counter/Timer Board. MSXB 036 may be connected to a DAP using various 100-line cabling options, or can be installed into a Digital Backplane.

- **Model MSXB 036-03**

Eurocards for Filtering – Analog

MSXB 048 Filtered Analog Input Expansion

The Microstar Laboratories Filtered Analog Input Expansion Board, part number MSXB 048, provides filtered analog input expansion for Analog Backplane systems. The Filtered Analog Input Expansion Board is compatible with the MSXB 030-01 and MSXB 031-01 Analog Backplanes.

The MSXB 048 provides anti-alias filtering and analog input expansion for 16 single-ended channels. MSXB 048 has a four-pole low-pass Butterworth filter on each of the 16 channels. Input signals are connected to the MSXB 048 by means of a DB-37 connector on the front panel or an optional 40-pin shrouded header that is not on the front panel. Up to 16 MSXB 048 boards can be connected to a single DAP/backplane system, providing up to 256 channels of filtering and input expansion.

MSXB 048 is compatible with the standard Data Acquisition Processor backplane system and optionally can be built in a stand-alone configuration. MSXB 048 most commonly is mounted in the standard Microstar Laboratories industrial enclosure and connects directly to the standard 68-line analog backplane. MSXB 048 derives +5V power from the 68-line backplane, with a typical power consumption of 8 Watts.

In addition to the input signals, MSXB 048 also can sample an onboard +5V reference and the onboard analog signal ground. This allows software offset calibration and verification of proper operation without changing the input cabling.

- **Model MSXB 048-03-100** **100Hz Filtered Analog Input Expansion, DB37 I/O**
- **Model MSXB 048-03-1K** **1kHz Filtered Analog Input Expansion, DB37 I/O**
- **Model MSXB 048-03-10K** **10kHz Filtered Analog Input Expansion, DB37 I/O**

- **Model MSXB 048-03-250** **250Hz Filtered Analog Input Expansion, DB37 I/O**
- **Model MSXB 048-03-2.5K** **2.5kHz Filtered Analog Input Expansion, DB37 I/O**
- **Model MSXB 048-03-25K** **25kHz Filtered Analog Input Expansion, DB37 I/O**

- **Model MSXB 048-03-500** **500Hz Filtered Analog Input Expansion, DB37 I/O**
- **Model MSXB 048-03-5K** **5kHz Filtered Analog Input Expansion, DB37 I/O**
- **Model MSXB 048-03-50K** **50kHz Filtered Analog Input Expansion, DB37 I/O**

MSXB 065 Signal Conditioning and Filtering for Voltage Inputs

See **Signal Conditioning (p. 21)** for more information.

MSXB 067 Signal Conditioning and Filtering for Resistive Sensors

See **Signal Conditioning (p. 23)** for more information.

iDSC 1816 Compatible Products

See **iDSC 1816 Compatible (p. 25)** for more information on the iDSC 1816 and its compatible products.

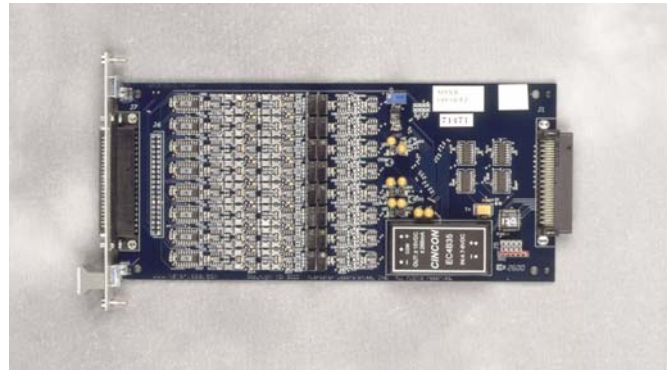

MSXB 048 Filtered Analog Input Expansion

Compatible with DAP 5216a, DAP 5200a,
DAP 5016a, DAP 5000a, and DAP 4000a/212

Compatible with DAP 5216a, DAP 5200a,
DAP 5016a, DAP 5000a, and DAP 4000a/212 PLUS
DAP 5400a and DAP 5380a

Eurocards for Isolation – Analog (Connects to the Digital Port)

MSXB 085 Isolated Analog Input and Output Expansion

The MSXB 085 Isolated Analog Input Expansion Board provides sixteen isolated analog inputs and two isolated analog outputs, and all inputs are differential, with 16-bit data conversion on the board itself – to minimize exposure to noise elsewhere in the system. The board can sample signal inputs at 333k samples per second and can update both signal outputs at 500k updates per second. A single DAP board can support up to eight MSXB 085 boards.

The board is a good fit in applications that have a number of analog inputs and a smaller number of analog outputs. Up to eight Isolated Analog Expansion Boards can be connected to a single DAP board for a total of 128 analog inputs and 16 analog outputs.

If you require groups of simultaneous isolated inputs, you can use multiple boards. Contact Applications Engineering at Microstar Laboratories for assistance.

MSXB 085 fits in an Industrial Enclosure or DAPserver and uses a DB-37 connector or Wago terminals.

- **Model MSXB 085-01** **DB-37 panel**
- **Model MSXB 085-02** **Wago terminals**

MSXB 075 and MSXB 076 Isolated 16-Bit Analog Output Expansion

See **Analog Outputs** (p. 15) for more information.

MSXB 084 (no photo shown) Isolated Analog Input Expansion

The MSXB 084 Isolated Analog Input Expansion Board provides isolated analog inputs for DAP systems. Use these boards to eliminate ground currents – a potential source of noise in your measurement and control signals – and eliminate timing errors.

MSXB 084 includes 16 differential analog inputs, with a shared ground, isolated from the PC. Each board offers high signal density and enables high channel counts. If you require a group of simultaneous isolated inputs, you can use multiple boards, but only one channel per board.

Up to 8 Isolated Analog Input Boards can be connected to a single DAP board for a total of 128 analog inputs.

MSXB 084 is installed in an Industrial Enclosure or DAPserver and uses a DB-37 connector or Wago terminals with BNCs.

- **Model MSXB 084-01** **DB-37 panel**
- **Model MSXB 084-02** **Wago terminals**

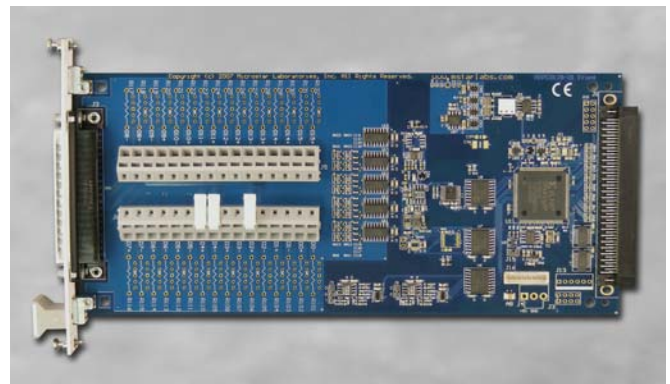

MSXB 085 Isolated Analog Expansion

Eurocards for Isolation – Analog

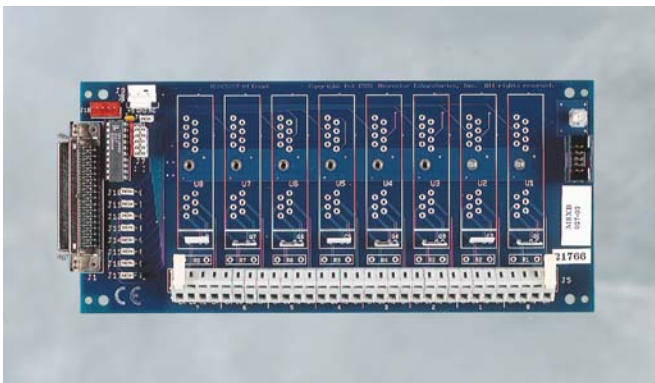

MSXB 027 Analog Isolation

MSXB 027 Analog Isolation

The MSXB 027 Analog Isolation Board accommodates up to eight isolation modules in any combination of input and output. Up to 64 5B Analog Isolation Boards can be connected to one DAP for a total of 512 isolated channels. When used in conjunction with Analog Output Expansion Boards, up to 66 of these channels can be specified as isolated analog outputs.

MSXB 027 requires cable MSCBL 040-01 or MSCBL 041-xx, and, for isolated analog outputs, MSCBL 014-01.

- **Model MSXB 027-05** **Wago terminals**
- **Model MSXB 027-06** **screw terminals**
- **Model MSXB 027-07** **Wago terminals,**
 no CJC
- **Model MSXB 027-08** **screw terminals,**
 no CJC

MSXB 078 Isolated Digital Expansion

The MSXB 078 Isolated Digital Expansion Board provides isolated digital expansion for Data Acquisition Processor (DAP) systems. Use these boards to eliminate ground currents – a potential source of noise in your measurement and control signals – and eliminate timing errors from high-channel count digital I/O.

MSXB 078 features simultaneous sampling and simultaneous updating for multiple boards. The board uses the same time base as the DAP board, so the digital inputs of the MSXB 078 are sampled concurrently with the analog inputs of the DAP.

Each MSXB 078 has 16 bits of input and 16 bits of output per board isolated from the PC. Multiple Digital Expansion Boards can be connected to a single DAP board for a total of 128 digital input lines and 1008 digital output lines. Input expansion is at a maximum with eight MSXB 078 boards (128 points). Output can be expanded to 1008 points by connecting 63 MSXB 078 boards to a single DAP.

MSXB 078 is installed in an Industrial Enclosure or DAPserver and uses an HD-62 connector. The HD-62 connector provides 62 high-density connections for digital signals. A cable or a 62-line discrete wire cable kit is used for wiring.

- **Model MSXB078-01** **HD-62 connector with LED termination panel**

MSXB 039 Opto Isolation

The MSXB 039 Opto-Isolator Board allows quick and secure connection of discrete wires at high DC and AC voltages to up to eight separately-available optically isolated digital switching/sensing modules. Each channel may be configured for input or output. Modules are available that can sense 280 VAC and 280 VDC, and that can switch 280 VAC @ 3 amps, 60 VDC @ 3 amps, and 200 VDC @ 1 amp. MSXB 039 handles only digital inputs and outputs.

There are several cabling options for the MSXB 039 Opto-Isolator Board. An MSXB 039 may be connected to a DAP using various 100-line cabling options, or can be installed into a Digital Backplane.

- **Model MSXB 039-01** **Wago terminals**
- **Model MSXB 039-02** **Wago terminals, external power**
- **Model MSXB 039-03** **screw terminals**
- **Model MSXB 039-04** **screw terminals, external power**
- **Model MSXB 039-05** **Wago terminals, right-angle 50-line I/O connector**

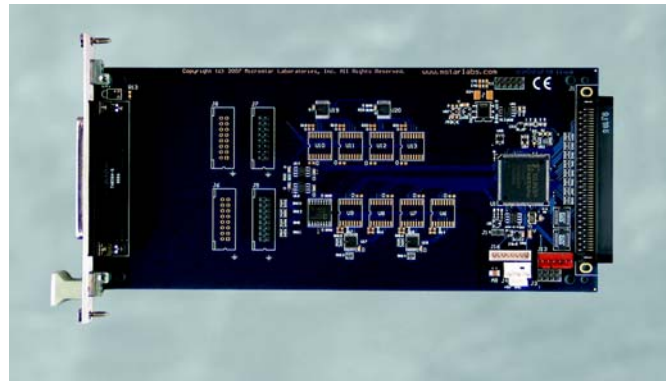

MSXB 078 Isolated Digital Expansion

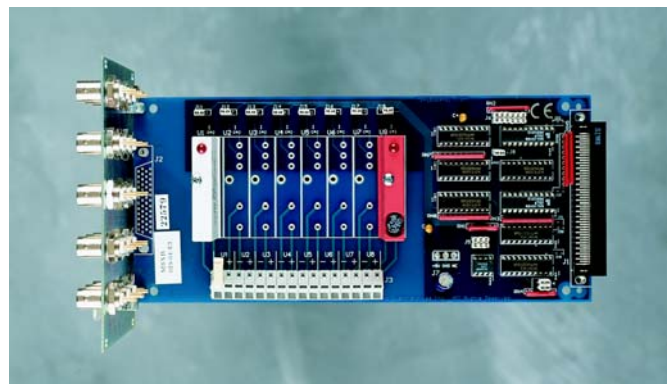

MSXB 039 Opto Isolation

Compatible with DAP 5216a, DAP 5200a, DAP 5016a, DAP 5000a, and DAP 4000a/212

Compatible with DAP 5216a, DAP 5200a, DAP 5016a, DAP 5000a, and DAP 4000a/212 PLUS DAP 5400a and DAP 5380a

Signal Conditioning – Analog

A sensor takes its form from its function (what it senses): accelerometer (motion); strain gauge (weight, stress, pressure); thermocouple, thermistor, RTD (temperature); etc. And each sensor generates a characteristic signal, typically a weak one.

Every signal conditioning/sensor interface product from Microstar Laboratories includes for each channel a dedicated instrumentation amplifier: a high input impedance differential op-amp circuit. High input impedance preserves the integrity of the measured signal, so that the measurement does not affect the signal. Low impedance outputs from the instrumentation amplifier match the input requirements of multiplexed high-speed data acquisition boards.

Every signal conditioning/sensor interface product from Microstar Laboratories lets you sample all channels simultaneously if you want to do that because your application requires inter-channel phase measurements for transfer function computations, or because you require simultaneous sampling for applications like multichannel spectral analysis. The sample-and-hold option eliminates phase errors introduced by sequential sampling.

Microstar Laboratories offers most signal conditioning/sensor interface products in two versions: with and without analog anti-alias filters. The anti-alias filters – on attached daughterboards – allow a wide selection of cutoff frequencies. For a sharper cutoff, or for programmable frequency response, follow the analog anti-alias filter with a digital FIRFILTER implemented in DAPL.

If your signal includes unwanted frequencies above half the sampling rate – above the Nyquist frequency – then order the version of the signal conditioning/sensor interface product with analog anti-alias filters. This guarantees that your sampled

Signal Conditioning / Sensor Interface Products

Signal conditioning amplifies, filters, converts, normalizes, and otherwise processes the signal from a sensor so that a data acquisition board can read it. Sensors sometimes require voltage or current excitation, and signal conditioning/sensor interface products from Microstar Laboratories provide this excitation as required, along with processing the signal.

Add these sensor interface products to your DAP-board data acquisition system to add signal conditioning – and other features.

Microstar Laboratories supports an expanding variety of sensor types. Contact us for more information about the developing product line.

data will not include alias frequencies that corrupt your results. When you order, choose the cutoff frequency appropriate for your application.

Each different sensor type commonly terminates with a specific connector. You can choose a signal conditioning/sensor interface product with a matching connector, or, for high-channel count applications, you may prefer high-density connectors.

Microstar Laboratories implements signal conditioning/sensor interface products as 3U Eurocard B boards to conform with the channel architecture the company uses.

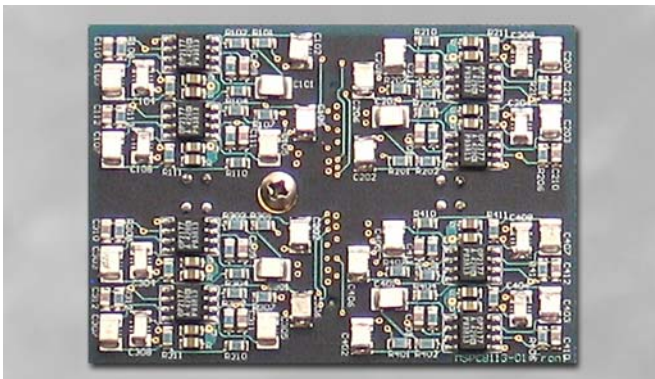

MSFM Filter Module

Additional Product MSFM – Filter Module for MSXB 065 and MSXB 067

The MSXB 065 and MSXB 067 options have analog anti-alias filters. The anti-alias filters – on attached daughterboards – allow a wide selection of cutoff frequencies.

When you order, choose the cutoff frequency appropriate for your application.

The daughterboard can be changed to adjust the cutoff frequency. Filter modules may be changed in the field, with only a small offset error. The available cutoff frequencies are 100 Hz, 250 Hz, 500 Hz, 1 kHz, 2.5 kHz, 5 kHz, 10 kHz, 25 kHz, 50 kHz.

MSXB 064 Signal Conditioning for Voltage Inputs

The MSXB 064 Signal Conditioning Expansion Board provides analog signal conditioning for voltage signals for Data Acquisition Processor systems. Each board has

- differential inputs
- jumper-selectable simultaneous sampling
- jumper-selectable gains of 1, 5, and 25

Signal Conditioning Expansion Boards are used in multichannel spectral analysis and other applications that require simultaneous acquisition of several channels. MSXB 064 and MSXB 065 usually are used for applications that require interchannel phase measurements such as applications that perform transfer function computations. These boards eliminate the phase error introduced by sequential sampling.

Each MSXB 064 Signal Conditioning Expansion Board has eight differential input channels and eight differential outputs to a DAP board.

The MSXB 064 provides signal conditioning expansion for Analog Backplane systems. The Signal Conditioning Expansion Board is compatible with Industrial Enclosures and Analog Backplanes.

- **Model MSXB 064-01** **DB37 panel**

MSXB 065 Signal Conditioning and Filtering for Voltage Inputs

The MSXB 065 Signal Conditioning Expansion Board provides the same analog signal conditioning for voltage signals as the MSXB 064 and adds filtering. Each board has

- differential inputs
- jumper-selectable simultaneous sampling
- jumper-selectable gains of 1, 5, and 25
- fourth-order anti-alias filters,
cutoff frequencies from 100 Hz to 50 kHz

Sampling introduces alias errors when the input signals contain energy at frequencies above half of the sampling rate. In addition to simultaneous sampling, the MSXB 065 board has fourth-order lowpass filters to eliminate the aliasing errors inherent in sampling under these conditions.

Each MSXB 065 has eight differential input channels and eight differential outputs to a DAP board. Each channel on MSXB 065 has a four-pole analog lowpass filter on a daughterboard; the daughterboard can be changed to adjust the cutoff frequency. The available cutoff frequencies are 100 Hz, 250 Hz, 500 Hz, 1 kHz, 2.5 kHz, 5 kHz, 10 kHz, 25 kHz, 50 kHz.

Each DAP board has an onboard processor with built-in filtering commands. By applying onboard digital filters to the output data from MSXB 065, it is possible to construct a wide range of filter responses, including very sharp lowpass filters.

- **Model MSXB 065-01** **DB37 panel**

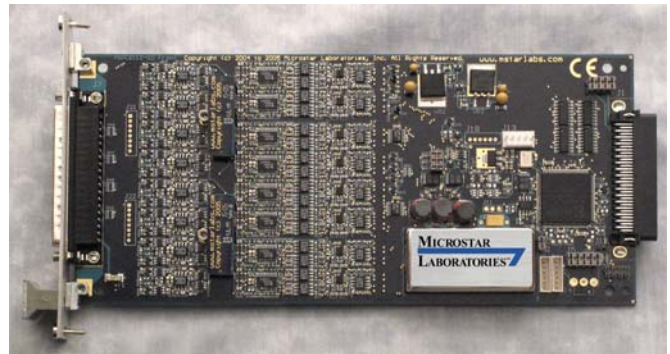

MSXB 064 Signal Conditioning for Voltage Inputs

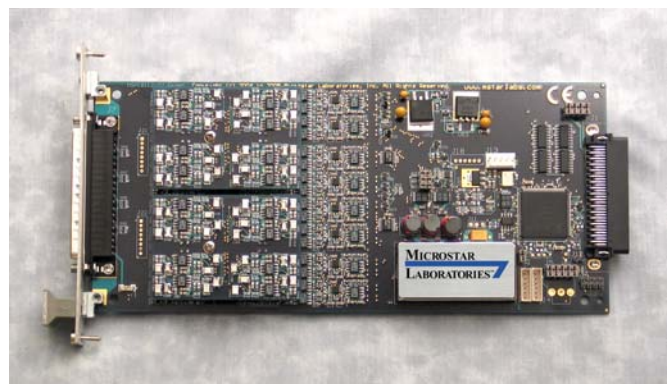

MSXB 065 Signal Conditioning and Filtering for Voltage Inputs

**Compatible with DAP 5216a, DAP 5200a,
DAP 5016a, DAP 5000a, and DAP 4000a/212**

Signal Conditioning – Analog (Continued)

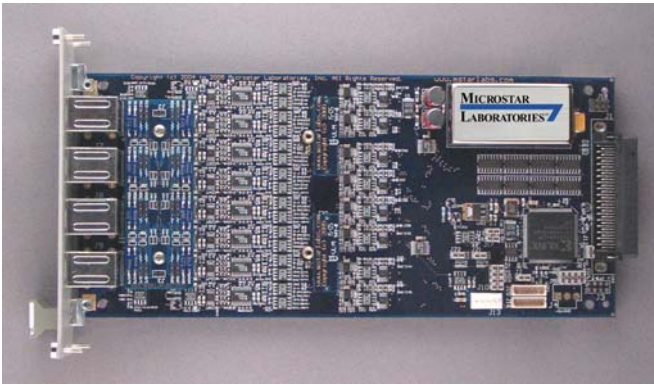

MSXB 066 Signal Conditioning for Resistive Sensors

MSXB 066 Signal Conditioning for Resistive Sensors

The MSXB 066 Signal Conditioning Expansion Board provides analog signal conditioning for strain gauges, load cells, RTDs, and other resistive sensors. MSXB 066 provides a flexible interface for quarter-bridge, half-bridge, and full-bridge sensors, with two to six wires for each sensor, with or without voltage sense feedback. A small daughterboard supports user-supplied bridge completion resistors.

Each MSXB 066 has

- eight differential inputs
- jumper-selectable simultaneous sampling
- jumper-selectable gains of
 - 20, 40, 100, 200, 500, and 1000 (for strain gauges and load cells), or
 - 1, 2, 5, 10, 25, and 50 (for RTDs)
- jumper-selectable differential voltage excitation of 1.024 V, 2.048 V, and 3.072 V

Each MSXB 066 supports

- eight bridge sensors per board
- one eight-pin mini-DIN connector for each sensor
- force/sense feedback
- sense voltage measurement

Signal Conditioning Expansion Boards are used in multichannel spectral analysis and other applications that require simultaneous acquisition of several channels. These boards eliminate the phase error introduced by sequential sampling.

The MSXB 066 has eight differential input channels and 16 differential outputs to a DAP board: eight for signals and eight to sense the excitation voltage.

Channel Architecture allows up to 15 MSXB 066 boards to connect to a single DAP board for up to 120 channels of resistive sensor input.

The MSXB 066 provides signal conditioning expansion for Analog Backplane systems. The Signal Conditioning Expansion Board is compatible with Industrial Enclosures and Analog Backplanes.

- **Model MSXB066-01** **high gain for strain gauges, load cells, etc.**
- **Model MSXB066-02** **low gain for RTDs**

Additional Product MSBCM – Bridge Completion Module for MSXB 066 and MSXB 067

Supports user-supplied bridge completion resistors, either surface-mount or through-hole. For additional applications that use the MSXB 066 or MSXB 067, but different sensors, simply configure an additional Bridge Completion Module and swap it in on the board.

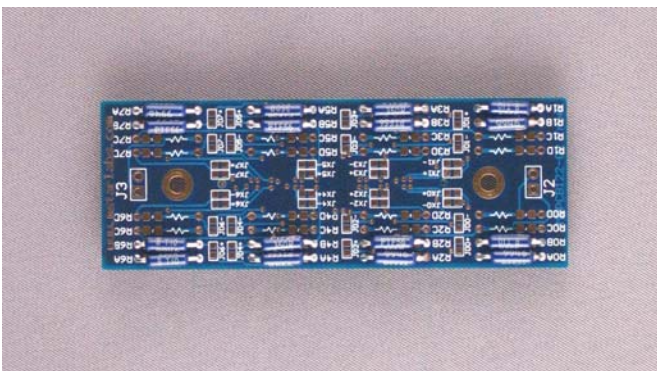

MSBCM001 Bridge Completion Module

MSXB 067 Signal Conditioning and Filtering for Resistive Sensors

The MSXB 067 Signal Conditioning Expansion Board provides analog signal conditioning for strain gauges, load cells, RTDs, and other resistive sensors. MSXB 067 provides a flexible interface for quarter-bridge, half-bridge, and full-bridge sensors, with two to six wires for each sensor, with or without voltage sense feedback. A small daughterboard supports user-supplied bridge completion resistors.

Each MSXB 067 has

- eight differential inputs
- jumper-selectable simultaneous sampling
- jumper-selectable gains of
 - 20, 40, 100, 200, 500, and 1000 (for strain gauges and load cells), or
 - 1, 2, 5, 10, 25, and 50 (for RTDs)
- jumper-selectable differential voltage excitation of 1.024 V, 2.048 V, and 3.072 V
- fourth-order anti-alias filters
- cutoff frequencies from 100 Hz to 50 kHz

Each MSXB 067 supports

- eight bridge sensors per board
- one eight-pin mini-DIN connector for each sensor
- force/sense feedback
- sense voltage measurement

Signal Conditioning Expansion Boards are used in multichannel spectral analysis and other applications that require simultaneous acquisition of several channels. These boards eliminate the phase error introduced by sequential sampling.

Sampling introduces alias errors when the input signals contain energy at frequencies above half of the sampling rate. In addition to simultaneous sampling, the MSXB 067 board has fourth-order lowpass filters to eliminate the aliasing errors inherent in sampling under these conditions.

The MSXB 067 Signal Conditioning Expansion Board has eight differential input channels and 16 differential outputs to a DAP board: eight for signals and eight to sense the excitation voltage. Each channel on MSXB 067 has a four-pole analog lowpass filter on a daughterboard; the daughterboard can be changed to adjust the cutoff frequency.

Each DAP board has an onboard processor with built-in filtering commands. By applying onboard digital filters to the output data from MSXB 067, it is possible to construct a wide range of filter responses, including very sharp lowpass filters.

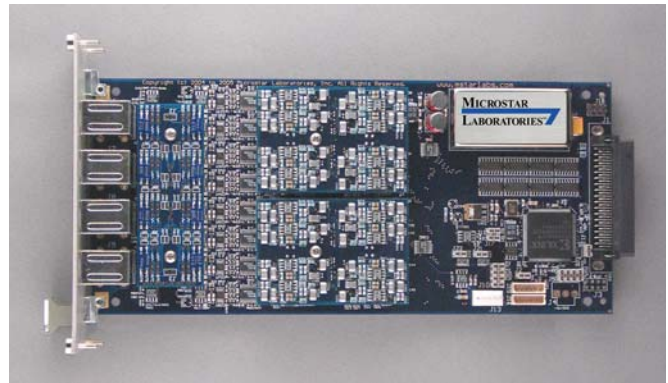

MSXB 067 Signal Conditioning and Filtering for Resistive Sensors

Channel Architecture allows up to 15 MSXB 067 boards to connect to a single DAP board for up to 120 channels of resistive sensor input.

The MSXB 067 provides signal conditioning expansion for Analog Backplane systems. The Signal Conditioning Expansion Board is compatible with Industrial Enclosures and Analog Backplanes.

- **Model MSXB067-01** **high gain for strain gauges, load cells, etc.**
- **Model MSXB067-02** **low gain for RTDs**

MSXB 027 Analog Isolation

See **Isolation – Analog (p. 18)** for more information.

MSXB 028 Simultaneous Sampling

See **Simultaneous Sampling (p. 24)** for more information.

MSXB 048 Filtered Analog Expansion

See **Isolation – Analog (p. 17)** for more information.

Compatible with DAP 5216a, DAP 5200a, DAP 5016a, DAP 5000a, and DAP 4000a/212

Compatible with DAP 5216a, DAP 5200a, DAP 5016a, DAP 5000a, and DAP 4000a/212 PLUS DAP 5400a and DAP 5380a

Eurocards for Quadrature Decoder – Digital

MSXB 050 Quadrature Decoder

The MSXB 050 Quadrature Decoder Board allows a Data Acquisition Processor to read quadrature-encoded signals through its digital port. Quadrature-encoded signals are often used to measure the angular velocity and angular position of wheels, gears, and motors.

The Quadrature Decoder Board has four input channels. Each channel can measure quadrature-encoded signals with frequencies up to 1 MHz. The board has a counter resolution of 16 bits, and can be extended to 32 bits with software provided on the DAPtools Basic CD. Up to six Quadrature Decoder Boards can be used in a system for a total of 24 channels.

There are several cabling options for the MSXB 050 Quadrature Decoder Boards. MSXB 050 may be connected to a DAP using various 100-line cabling options, or can be installed into a Digital Backplane.

- **Model MSXB 050-01** **DB25 and Wago terminals**

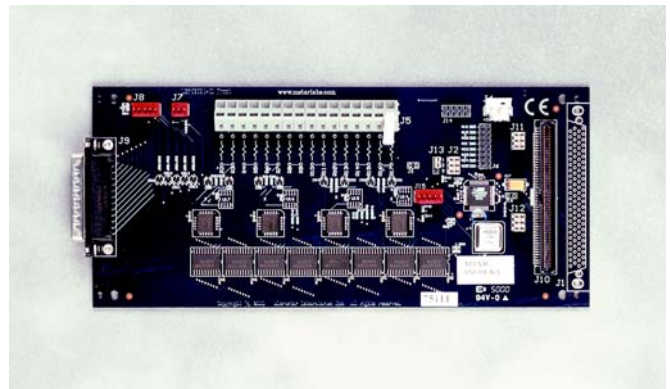

MSXB 050 Quadrature Decoder

Eurocards for Simultaneous Sampling – Analog

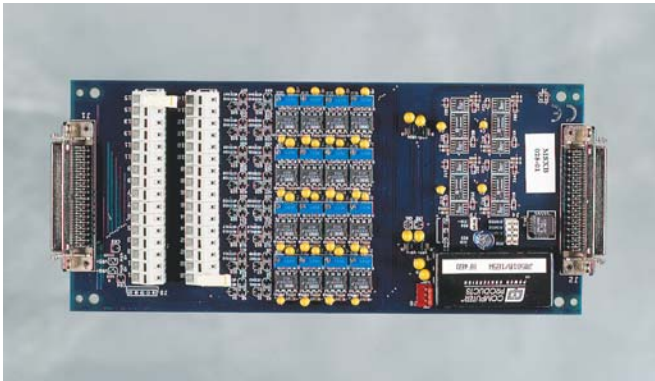

MSXB 028 Simultaneous Sampling

MSXB 064 & MSXB 065 Signal Conditioning for Voltage Inputs

See **Signal Conditioning** (p. 21) for more information.

MSXB 066 & MSXB 067 Signal Conditioning for Resistive Sensors

See **Signal Conditioning** (p. 22-23) for more information.

Compatible with DAP 5216a, DAP 5200a,
DAP 5016a, DAP 5000a, and DAP 4000a/212

Compatible with iDSC 1816

888 MSTARLABS (888 678-2752)

MSXB 028 Simultaneous Sampling

Simultaneous Sampling Boards are used in multi-channel spectral analysis and other applications that require simultaneous acquisition of several channels. The MSXB 028 usually is used for applications that require inter-channel phase measurements such as applications that perform transfer function computations. This board eliminates phase error introduced by sequential sampling.

Up to 16 boards can be connected to a DAP for a total of 256 channels. The MSXB 028 is a 12-bit board. If you need 16-bit simultaneous sampling, take a look at the iDSC 1816.

The a-Series Simultaneous Sampling Board requires cable MSCBL 40-01 or MSCBL 041-xx.

- **Model MSXB 028-01** **Wago terminals**
- **Model MSXB 028-02** **Wago terminals,
external power**
- **Model MSXB 028-03** **screw terminals**
- **Model MSXB 028-04** **screw terminals,
external power**
- **Model MSXB 028-05** **Wago terminals,
vertical input
connector**

Compatible with DAP 5216a, DAP 5200a,
DAP 5016a, DAP 5000a, and DAP 4000a/212 PLUS
DAP 5400a and DAP 5380a

iDSC 1816 Compatible

Download the Anti-Aliasing Catalog for information about the iDSC 1816, a specialized DAP board with onboard analog filters, as well as related items that work with that: MSXB 042, MXSB 043, MSXB 044, and MSXB 045. For completeness, this page includes brief descriptions of these last four products.

MSXB 042 Analog Termination

The MSXB 042 Analog Termination Board allows quick and secure connection of discrete wires to the iDSC 1816 Board.

MSXB 042 includes locations to install voltage divider resistors and 0-20mA termination resistors, as well as a Cold Junction Compensation (CJC) circuit for thermocouple applications.

MSXB 042 requires cable MSCBL 048-01.

- **Model MSXB 042-01** **Wago terminals, D connector**

MSXB 043 BNC Termination

MSXB 043 BNC Termination Boards for the iDSC 1816 fit inside enclosures. Access the BNC connectors on the front panel of the enclosure.

- **Model MSXB 043-01**

MSXB 044 Expansion

The MSXB 044 Expansion Board works with the iDSC 1816 to add signal conditioning to the data acquisition and anti-aliasing capabilities. Four MSXB 044 boards are included in each MSSC-8 module. Purchase the MSXB 044 as part of a complete SCS system: an enclosure and 1, 2, 3, or 4 MSSC-8 modules, for a total of 8, 16, 24, or 32 channels.

The MSXB 044 board itself provides direct connection to sensors, and offers many signal-conditioning services in a single convenient package.

- **Model MSXB 044-01**

MSXB 045 LVDS

The MSXB 045 LVDS Board works with multiple iDSC 1816 boards to provide synchronization for many channels of data. An MSXB 045 board in each of two or more networked PCs, that each contain one or more iDSC 1816 boards, allows the whole networked system to work as a single synchronized system with possibly hundreds of conditioned channels.

MSXB 045 uses cable MSCBL 083-01 and one of MSCBL 084-01 or MSCBL 085-01.

- **Model MSXB 045-01** **transmitter/internal receiver**
- **Model MSXB 045-10** **external receiver only**

DAP 4000a/112 Compatible

There are two DAP 4000a models: the DAP 4000a/212 and the DAP 4000a/112.

The DAP 4000a/212 model includes a high-channel count expansion option. Choose the DAP 4000a/212 for the benefits associated with onboard intelligence when you have light-to-medium real-time processing requirements. The DAP 4000a/112 model has exactly the same attributes as the DAP 4000a/212 except for the high-channel count option. Choose the DAP 4000a/112 over the DAP 4000a/212 when your application requires only relatively few inputs. If later you require more inputs, you can return your DAP 4000a/112 to have the factory install the high-channel count option that upgrades your board to a DAP 4000a/212.

The DAP 4000a uses the same type of analog and digital connectors as other a-Series boards, so the DAP 4000a is compatible with the same cabling and termination. All a-Series Data Acquisition Processor boards share the same Channel Architecture, although input expansion boards cannot be used with the DAP 4000a/112 model.

The following boards can be used with a DAP 4000a/112 with full functionality, but with no additional input expansion capabilities.

- MSTB 008 – Digital Termination, p. 12
- MSTB 009 & MSTB 011 – Analog Termination, p. 12, 13
- MSXB 027 – Analog Isolation, p. 18
- MSXB 032 & MSXB 056 – Analog Output Expansion, p. 15
- MSXB 037 – Analog Input, Termination only, p. 14
- MSXB 038 – Digital Expansion, p. 16
- MSXB 039 – Digital Opto-Isolation, p. 19
- MSXB 048 – Filtered Analog Input, Termination only, p. 17
- MSXB 060 & MSXB 061 – Differential Analog Input, Termination only, p. 14
- MSXB 064 – Signal Conditioning for Voltage Inputs, p. 21
- MSXB 065 – Signal Conditioning and Filtering for Voltage Inputs, p. 21
- MSXB 066 – Signal Conditioning for Resistive Sensors, p.22
- MSXB 067 – Signal Conditioning and Filtering for Resistive Sensors, p. 23

Inside an Industrial Enclosure – Digital

Industrial enclosures provide dense packaging for systems with many signals or with multiple isolation, counter, or sensor interface boards. Rack-mount enclosure options include full-size 19-inch and also half-size models.

Industrial enclosures use an analog or digital backplane to collect signals from the accessory or termination Eurocards while preserving signal quality. The type of backplane is indicated by a Eurocard part number suffix indicating analog or digital. Shielded cables then connect the backplane to the Data Acquisition Processor boards on the host bus.

The backplane comes pre-installed with the rack.¹ Interface boards connecting the backplane to the rear connector panel occupy two of the mounting slots, leaving 20 available slots for boards and connector panels on full-size models, or nine slots on half-size models. Full-size racks can also be configured with a split backplane, so that the full rack is the equivalent of an analog half-rack and a digital half-rack, each with nine available mounting slots, within one package.

All other Eurocard termination and accessory cards for channel architecture are ordered separately. For systems with specialized connector, cabling, and termination requirements, you can mount other standard form factor boards in the shielded rack.

¹Note: Customers wanting to build their own Eurocard enclosures for Microstar Laboratories Eurocards or boards of their own design can buy analog or digital backplanes, and analog or digital interface boards, as separate items. The Eurocard part number suffixes for these interface boards do not follow the usual suffix conventions. Contact Microstar Laboratories for more information.

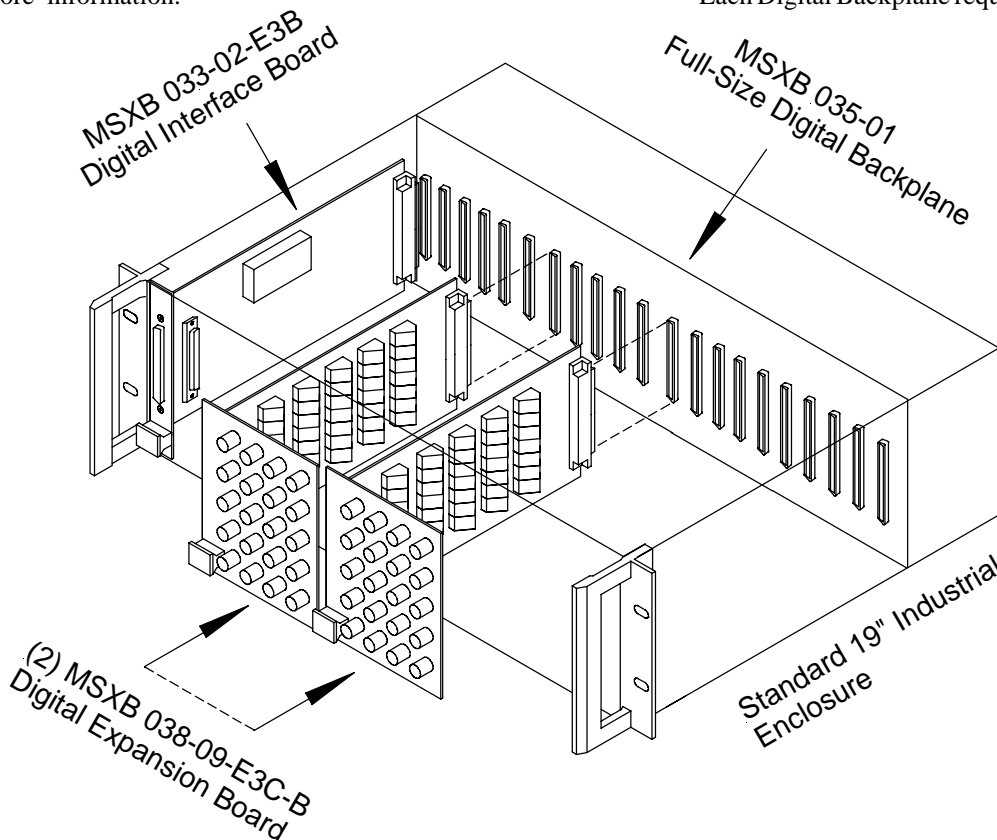

MSXB 033 Digital Backplane Interface

The Microstar Laboratories Digital Backplane Interface Board, part number MSXB 033, interfaces the Digital Backplane with a Data Acquisition Processor. The Digital Backplane Interface Board must be installed in the Digital Backplane to connect the backplane to a Data Acquisition Processor.

One Digital Backplane Interface Board is required for each Digital Backplane.

The Digital Backplane Interface Board has several cabling options. Contact Microstar Laboratories for more information.

- **Model MSXB 033-01**
- **Model MSXB 033-02** **External Power**

MSXB 034 and MSXB 035 Digital Backplanes

The Microstar Laboratories Digital Backplanes allow easy digital input and output expansion for large systems. Backplanes typically are used with Industrial Enclosures, which provide electrical shielding and provide a compact unit for multiple Eurocards.

Digital Backplanes provide expansion slots to accommodate compatible digital Eurocards. Digital Backplanes are passive, and connect all signals in each of the expansion slots in parallel. All expansion slots are identical.

Each Digital Backplane requires a Digital Backplane Interface Board.

- **Model MSXB 034-01**
Half-Size Digital Backplane
(10 expansion slots)
- **Model MSXB 035-01**
Full-Size Digital Backplane
(21 expansion slots)

The Full-Size Digital Backplane is compatible with any VME standard subrack enclosure that has the following dimensions: 84-HP length, 3U height, and 220mm depth.

The Half-Size Digital Backplane is compatible with any VME standard subrack enclosure that has the following dimensions: 42-HP length, 3U height, and 220mm depth.

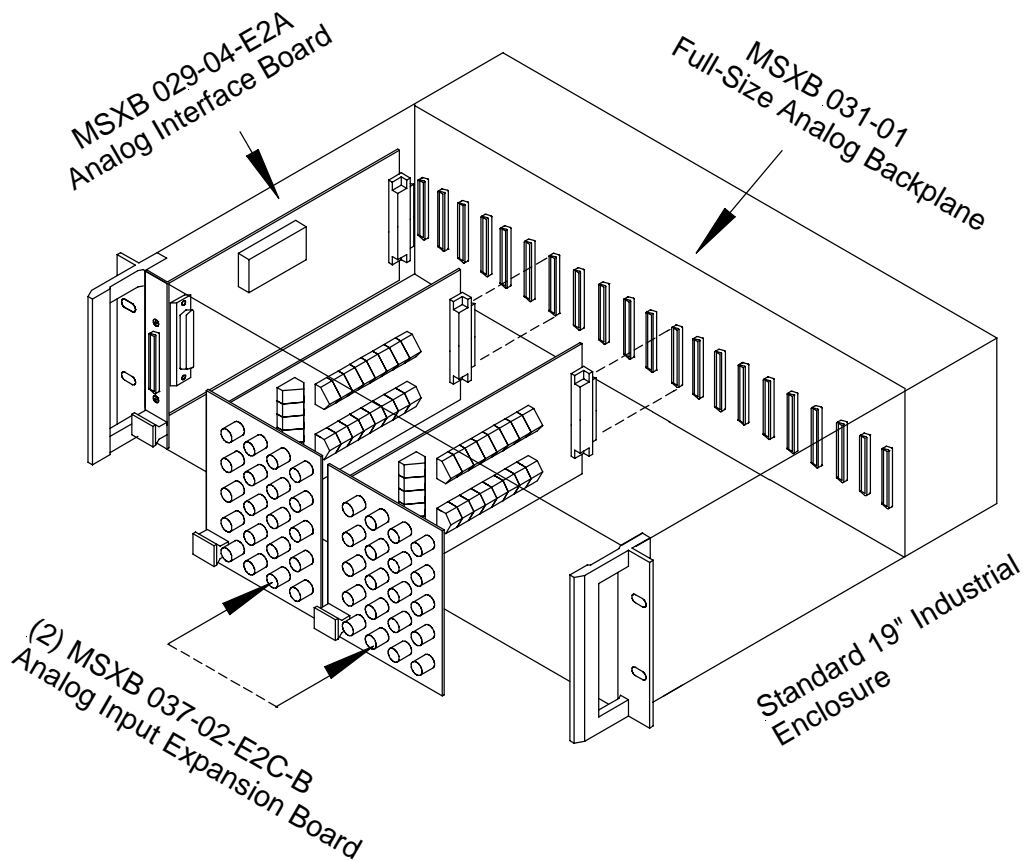

**MSXB 029
Analog Backplane Interface**

The Microstar Laboratories Analog Backplane Interface Board, part number MSXB 029, interfaces the Analog Backplane with a Data Acquisition Processor. The Analog Backplane Interface Board must be installed in the Analog Backplane to connect the backplane to a Data Acquisition Processor.

One Analog Backplane Interface Board is required for each Analog Backplane.

The Analog Backplane Interface Board requires cable MSCBL 040-01 or MSCBL 041-xx.

- Model MSXB 029-03-E2A
- Model MSXB 029-04-E2A External Power

**MSXB 030 and MSXB 031
Analog Backplanes**

The Microstar Laboratories Analog Backplanes allow easy analog expansion for large systems. Backplanes typically are used with Industrial Enclosures, which provide electrical shielding and form a compact unit for multiple Eurocards.

Analog Backplanes provide expansion slots to accommodate compatible analog Eurocards. Analog Backplanes are passive, and connect all signals in each of the expansion slots in parallel. All expansion slots are identical.

- Model MSXB 030-01 **Half-Size Analog Backplane (10 expansion slots)**
- Model MSXB 031-01 **Full-Size Analog Backplane (21 expansion slots)**

The Full-Size Analog Backplane is compatible with any VME standard subrack enclosure that has the following dimensions: 84-HP length, 3U height, and 220mm depth.

The Half-Size Analog Backplane is compatible with any VME standard subrack enclosure that has the following dimensions: 42-HP length, 3U height, and 220mm depth.

Understanding Signal Interface Eurocard Part-Number Suffixes

Most Microstar Laboratories Eurocard part numbers (e.g., MSXB028-05-E2C) include the part number (MSXB028), the hardware revision (05), and a three-character suffix (E2C), that shows how the Eurocard connects to a DAP and to the world outside. The table below shows the options available for each Eurocard; the table on the next page partially decodes the three-character suffixes.

MSTB 008: Digital Termination Boards	J3C J3Y
MSTB 009: Analog Termination Boards	A2C A2Y
MSTB 010: Termination Boards for the DAP 820 and DAP 840	C1C
MSTB 011: Analog Termination Boards with DB37 Connectors	
MSXB 018: Analog Input Expansion Boards	A2Z B2Z
MSXB 027: Analog Isolation Boards	A2C A2Y E2F E2V
MSXB 028: Simultaneous Sampling Boards	A2A A2C A2Y E2A E2C E2Y
MSXB 029: Analog Backplane Interface Boards	
MSXB 030 & MSXB 031: Analog Backplanes	
MSXB 032: 12-Bit Analog Output Expansion Boards	C3C C3Y E3E E3Y
MSXB 033: Digital Backplane Interface Boards	
MSXB 034 & MSXB 035: Digital Backplanes	
MSXB 036: Counter/Timer Boards	C3C C3Y E3C E3E E3Y
MSXB 037: Analog Input Expansion Boards	A2Y E2C E2K E2Y
MSXB 038: Digital Expansion Boards	C3B C3C C3Y E3B E3C E3X E3Y
MSXB 039: Digital Opto-Isolator Boards	C3C C3Y C3D E3F E3W E3G
MSXB 042: Analog Termination Boards for the iDSC 1816	
MSXB 043: BNC Termination Boards for the iDSC 1816	
MSXB 044: Signal Conditioning Boards for the MSSC-8	
MSXB 045: LVDS Boards for iDSC 1816 synchronization	
MSXB 048: Filtered Analog Input Expansion Boards	E2K
MSXB 050: Quadrature Decoder Boards	C3F C3Z K3Z E3M
MSXB 056: 16-Bit Analog Output Expansion Boards	C3C C3Z E3E E3Y
MSXB 060 & MSXB 061: Differential Analog Input Expansion	E2R E2S
MSXB 064: Signal Conditioning Expansion for Voltage Inputs	E2K
MSXB 065: Signal Conditioning and Filtering Expansion for Voltage Inputs	E2K
MSXB 066: Signal Conditioning Expansion for Resistive Sensors	E2Q01
MSXB 067: Signal Conditioning and Filtering Expansion for Resistive Sensors	E2Q01
MSXB 075 & MSXB 076: Isolated 16-Bit Analog Output Expansion Boards	E3K-F
MSXB 078: Isolated Digital Expansion Boards	E3P
MSXB 084: Isolated Analog Input Expansion Boards	E3B E3C E3K E3X E3Y
MSXB 085: Isolated Analog Input and Output Expansion Boards	E3B E3C E3K E3X E3Y

In the list above, part-number suffixes following the descriptions identify the enclosure versions. E2x identifies a Eurocard designed for an analog backplane, E3x identifies a Eurocard designed for a digital backplane. See the table on the next page for more detail.

Example 1: The suffix E2C in the part number MSXB028-05-E2C indicates that the MSXB028 Simultaneous Sampling board (product rev 5) connects to a DAP through the analog backplane in an Industrial Enclosure (IE) like the MSIE002-06. It samples inputs applied to 20 BNC connectors in a front panel that covers five slots. (A full-size backplane has 20 available slots; a half-size backplane has 9.)

Example 2: The suffix C3C in the part number MSXB039-01-C3C, indicates that this Eurocard, the MSXB039 Opto Isolation board (product rev 1), occupies a Single Board Enclosure (SBE) with 20 BNC connectors on its front panel, and connects to a DAP through a 100-line cable, an MSCBL054.

Each row shows a suffix preceded by appropriate cable/connection to a DAP, followed by enclosure [:<number of slots>] and type of connector for sensor/actuator. Some customers use ribbon cables in special cases. However, the cables listed here fit every case, and most people choose them.

Connection to the DAP board, indicated in the **first letter** and the **digit** of the...

Eurocard suffix, the last letter of which varies with...

Type of Enclosure (SBE=Single Board Enclosure; IE=Industrial Enclosure) and the...

Panel on Enclosure where the signals come in to the Eurocard

50-line connection

MSCBL048	C1C	SBE	20 BNC panel	Note: The 50-line cable listed here connects directly to a DAP 840, or to an iDSC 1816. No other DAP boards use 50 lines.
MSCBL048	C1Y	SBE	blank panel	
MSCBL048	C1Z	n/a	*	

68-line connection

MSCBL040	A2A	SBE	68-line panel	Note: The 68-line cable listed here connects directly to a DAP. See Channel Architecture for details and diagrams.
MSCBL040	A2C	SBE	20 BNC panel	
MSCBL040	A2Y	SBE	blank panel	
MSCBL040	A2Z	n/a	*	Note: The MSXB 029 Analog Backplane Interface Board does not follow this convention.
MSCBL040	B2Z	n/a	*	
Analog Backplane	E2A	IE:1	68-line panel	
Analog Backplane	E2C	IE:5	20 BNC panel	
Analog Backplane	E2F	IE:5	20 BNC panel	
Analog Backplane	E2K	IE:1	DB37 panel	
Analog Backplane	E2R	IE:1	HD78 panel	
Analog Backplane	E2S	IE:2	Dual HD78 panel	
Analog Backplane	E2Q01	IE:2	Eight 8-pin mini-DIN panel	
Analog Backplane	E2V	IE:5	blank panel	
Analog Backplane	E2X	IE:4	blank panel	
Analog Backplane	E2Y	IE:1	blank panel	

100-line connection

MSCBL054	C3B	SBE	100-line panel	Note: The 100-line cables listed here connect to a DAP through a digital filter adapter board like the MSCBL076.
MSCBL054	C3C	SBE	20 BNC panel	
MSCBL054	C3D	SBE	50-line panel	
MSCBL054	C3F	SBE	DB25 panel	Note: An alternate version for every BNC panel includes a signal ground isolated from chassis ground. An added -B identifies this version.
MSCBL054	C3Y	SBE	blank panel	
MSCBL054	C3Z	n/a	*	
Digital Backplane	E3B	IE:1	100-line panel	Note: The MSXB 033 Digital Backplane Interface Board does not follow this convention.
Digital Backplane	E3C	IE:5	20 BNC panel	
Digital Backplane	E3E	IE:1	4 BNC panel	
Digital Backplane	E3F	IE:5	20 BNC panel	
Digital Backplane	E3G	IE:4	50-line panel	
Digital Backplane	E3K	IE:1	DB37 panel	
Digital Backplane	E3K-F	IE:1	DB37 panel, female	
Digital Backplane	E3M	IE:1	DB25 panel	
Digital Backplane	E3P	IE:1	HD62 panel	
Digital Backplane	E3W	IE:4	blank panel	
Digital Backplane	E3X	IE:4	blank panel	
Digital Backplane	E3Y	IE:1	blank panel	
MSCBL054	J3C	SBE	20 BNC panel	
MSCBL054	J3Y	SBE	blank panel	
MSCBL058	K3Z	n/a	*	

* See individual Eurocard descriptions for termination on unenclosed models.

(K denotes square AMP ribbon-cable connector)

Cables

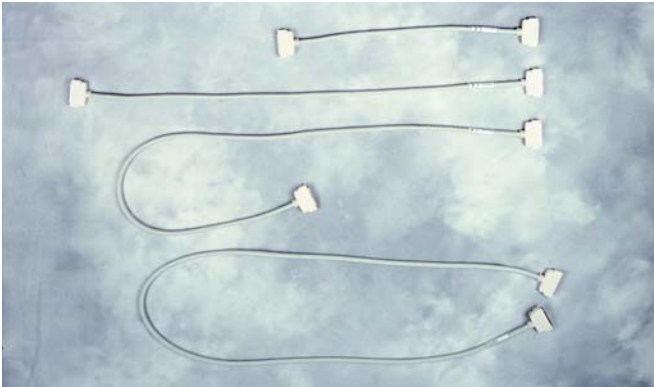

MSCBL 040: Four Standard Lengths, -L18 on Top

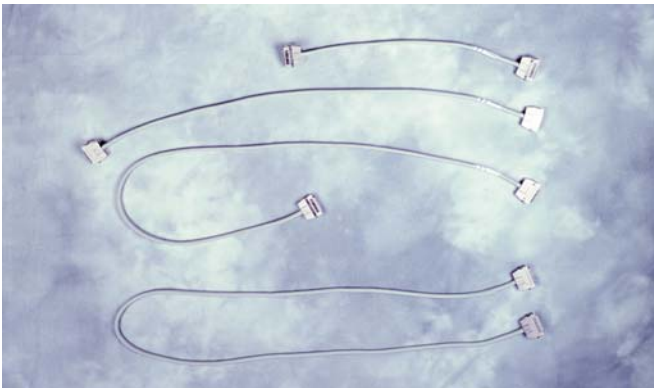

MSCBL 048: Four Standard Lengths, -L18 on Top



MSCBL 054: Four Standard Lengths, -L18 on Top

Cables connect DAPs to Eurocards and provide connections between DAPs and between Eurocards. Eurocard part number suffixes contain information on connecting DAPs to Eurocards as well as on enclosure options.

Enclosed Eurocards connected with shielded cables protect against electromagnetic interference. The Microstar Laboratories channel architecture makes it easy to configure systems with this protection. To do this for applications with low channel counts, choose from Eurocards already enclosed – each in its own single-board enclosure. Connect a single-board enclosure to a DAP with one of these three cables: MSCBL 048, MSCBL 040, or MSCBL 054, depending on whether the Eurocard requires a 50-, 68-, or 100-line connection to the DAP. The table on page 29 indicates the number of lines required. An MSCBL 054 connects to a DAP through a digital filter adapter board like the MSCBL 076. See the diagram on page 6.

For applications with higher channel counts, Eurocards connect to a DAP through an industrial enclosure backplane, interface, and cables. An analog backplane connects through its interface and a 68-line round, shielded cable, MSCBL 040, to the DAP analog connector in the PC back panel. A digital backplane connects through its interface and a 100-line round, shielded cable, MSCBL 054, to a digital connector in the PC back panel with integral digital filter adapter board, MSCBL 076; this occupies the PC slot next to the DAP and connects through its own short ribbon cable to the board-mounted digital connector on the DAP. The short ribbon cable runs entirely within the PC enclosure, and this shields it. See the diagram on page 6.

For any system where electromagnetic interference matters, choose only items marked CE, except where no part of the electrical path runs outside an enclosure. In practice, this greatly simplifies the selection by restricting the list of possible connections for new products in most cases to

- MSCBL 040** 68-line cable, described above
- MSCBL 048** 50-line cable, described above
- MSCBL 054** 100-line cable, described above
- MSCBL 063** 1-slot 68-line connector in one enclosure to allow a daisy chain to another
- MSCBL 076** PC back-panel 1-slot 100-line connector, described above
- MSCBL 078** synchronization cable for multiple iDSC 1816 systems
- MSCBL 101** synchronization cable for multiple DAP systems

Cables (Continued)

You may order any item in this section by part number from the Microstar Laboratories price list. Most -L36 cables also come in standard lengths of 18 inches, 54 inches, and 72 inches. Contact us for custom cable options.

The CE mark indicates that the cable meets the EMC Directive 89/336/EEC.

Note: 50-line cables are used with the DAP 840. 68-line cables connect to the analog connector of a-Series DAPs. 100-line cables carry all-digital signals. Some older DAP models use 40-line cables for digital and analog connections, and 10-line cables for analog expansion control; customers who still use these older boards may require these cables.

All 68-line and all current 50-line cables have D-style connectors. All 40-line and 10-line cables have square connectors. Some 100-line cables have square connectors, others have D-style connectors.

Square connectors have 90-degree corners and fit into complementary board-mounted DAP or Eurocard connectors. Their all-plastic construction provides no electromagnetic shielding.

Metal-and-plastic D-style connectors fit over complementary DAP or Eurocard connectors, shielding the connection. Ribbon cables that run outside enclosures do not provide electromagnetic shielding, even if they include D-style connectors.

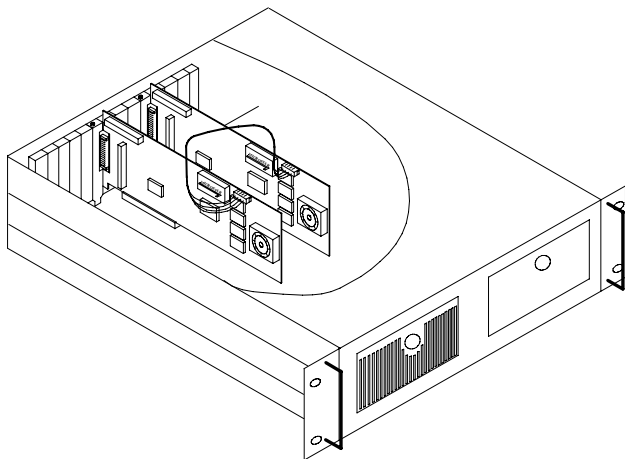

MSCBL 101 connecting two DAP 5200a boards in a PC.



MSCBL 063-01-L4.5

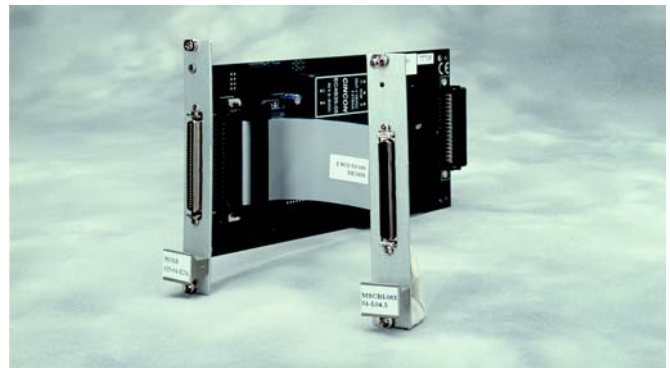

MSXB 029 with an MSCBL 063-01-L4.5 Plugged In

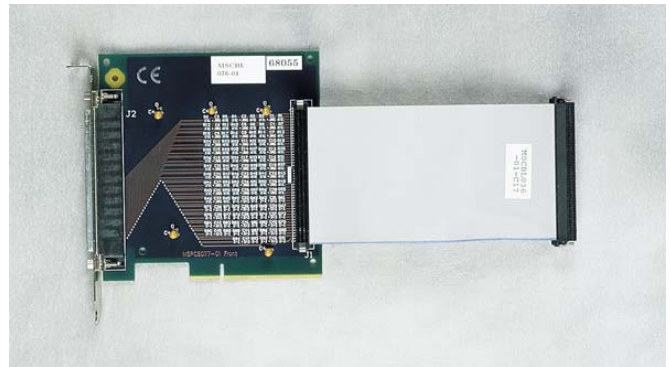

MSCBL 076



MSCBL 078 Connecting Two iDSC 1816 Boards

- **Argentina & Chile**
INGENIERIA C & C
Telephone: 54-3543-430315
Fax: 54-351-4234108
info@controlcomp.com
www.controlcomp.com
- **Australia**
Sci Tech Pty Ltd.
Telephone: (03) 9480 4999
Fax: (03) 9416 9959
con@scitech.com.au
www.scitech.com.au
- **Austria**
DEWETRON Ges.m.b.H.
Telephone: 0316-3070
Fax: 0316-3070-90
sales@dewetron.com
www.dewetron.com
- **Belgium**
Dimed N.V./S.A.
Telephone: 03 / 236.64.65
Fax: 03 / 236.64.62
info@dimed.be
www.dimed.be
- **Brasil**
InterComp Eletrônica Ltda.
Telephone: (5511) 3085-2733
Fax: (5511) 3088-2389
vendas@intercomp.com.br
www.intercomp.com.br
- **China**
Dalian Eddytek Company Limited
Telephone: +86-411-3960 9588
Fax: +86-411-3920 9600
info@eddytek.com.cn
www.eddytek.com.cn
- **China**
VolWin Technologies Co.Ltd
Telephone:
+86-10-88820040/41/42/43
Fax: +86-10-88820045
volwin@volwin.cn
www.volwin.cn
- **Finland**
Novotek Finland Oy
Telephone: 019-871-131
Fax: 019-871-1300
info@novotek.fi
www.novotek.fi
- **France**
Acquisys
Telephone: (33) 1 34 52 40 90
Fax: (33) 1 34 52 40 91
info@acquisys.fr
www.acquisys.fr
- **Germany**
measX GmbH & Co. KG
Telephone: +49 2166 9520 - 0
Fax: +49 2166 9520 -20
info@measx.com
www.measx.com
- **India**
Epsilon Embedded Computing (P) Ltd.
Telephone: +91-80-2543-5165
Fax: +91-80-2543-5166
praveen.k@epsilonembedded.com
www.epsilonembedded.com
- **Italy**
Ampere S.p.A.
Telephone: 02-678.49.1
Fax: 02-66.98.13.63
info@amperespa.it
www.amperespa.it
- **Japan**
TOYO Corporation
Telephone: +81-3-3279-0771
Fax: +81-3-3246-0645
dataacq@toyo.co.jp
www.toyo.co.jp
- **Korea**
Hanmac Corporation
Telephone:
02-467-7447
Fax: 02-467-6816
www.hanmacco.co.kr
- **Netherlands**
Daqpoint Benelux B.V.
Telephone: +31 162 465 900
Fax: +31 162 465 869
E-mail: info@daqpoint.nl
www.daqpoint.nl
- **Romania**
InterNET SRL
Telephone:
0040.21.312.1662
Fax: 0040.21.312.1663
E-mail: internet@inter-net.ro
www.inter-net.ro
- **Singapore**
Bliss Services Pte. Ltd.
Telephone: (65) 6338 1300
Fax: (65) 6338 1900
bliss@singnet.com.sg
www.blissautomation.com
- **South Africa**
MechCal
Telephone: (012) 347 7729
Fax: (012) 347 7929
info@mechcal.co.za
www.mechcal.co.za
- **Spain & Portugal**
Aries Ingenieria Y Sistemas, S.A.
Telephone:
91-570-27-37
Fax: 91-570-27-66
electronica@aries.com.es
- **Sweden**
System Technology Sweden AB
Telephone: 013-35 70 30
Fax: 013-14 05 30
sales@systemtech.se
www.systemtech.se
- **Switzerland**
A-Tech & Consulting GmbH
Telephone: 056 634 26 26
Fax: 0566 345 345
a-tech@swissonline.ch
www.a-tech.ch
- **Turkey**
MARMATEK
Telephone:
+90216 367 10 20 (PBX)
Fax: +90216 367 10 19
info@marmatek.com
- **United Kingdom**
Amplicon Liveline Limited
Telephone: (01273) 608 331
Fax: (01273) 570 215
tecsales@amplicon.co.uk
www.amplicon.co.uk